



# LRS 2002 Quadsaw

User manual

# EN

2. edition

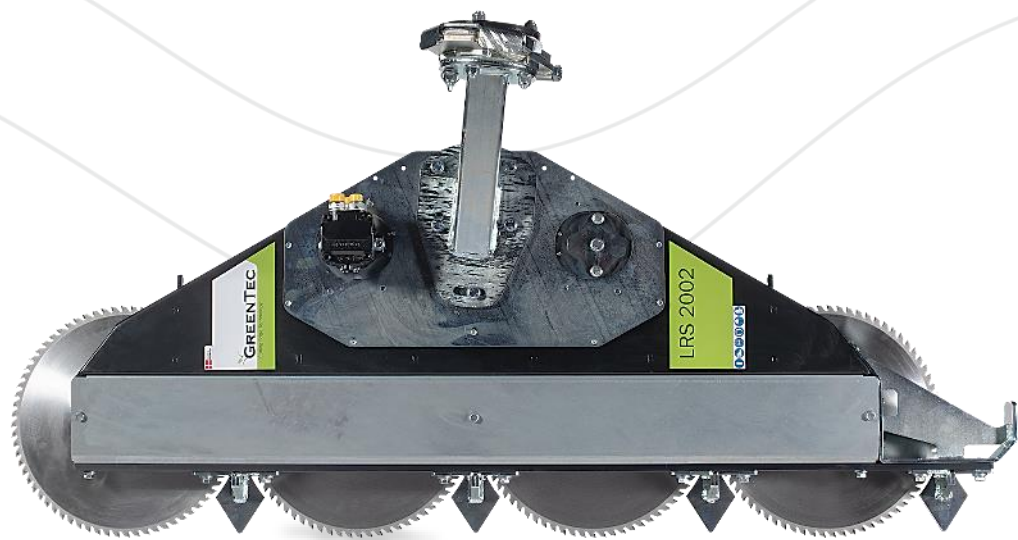

The original content of this user manual cannot be re-produced, distributed, transmitted, transcribed, or translated without the prior written permission from GreenTec.

Copyright © 2025 GreenTec A/S  
All rights reserved.

 **Made in Denmark** |    
Designed and manufactured

 **GREENTEC**  
Cutting Edge Technology

Merkurvej 25, DK-6000 Kolding  
+45 75 55 36 44 | [info@GreenTec.eu](mailto:info@GreenTec.eu) | [www.GreenTec.eu](http://www.GreenTec.eu)



# LRS 2002 Quadsaw

## User manual

---

2. edition – January 2025  
(Original version)

### ! IMPORTANT !

For correct operation, this **GreenTec LRS 2002 Quadsaw** must be mounted on an approved boom mower or multi carrier with an approved vehicle.

It is important that the operator is given both the user manual, spare parts book, and all other relevant technical documentation for both the Multi Carrier, attachment tool and vehicle before the machine is put into use for the first time.

It is important that the operator fully understands the contents of the instruction material before using the machine.

This user manual must accompany the machine and must always be available to the operator.

In case of later resale of the machine, all relevant technical documentation must be handed over to the new owner.

The content of the user manual is based on information, standards, and regulations, valid at the time of publication.

As our products are under continuous development and improvement, changes to the specifications may occur.

If there is information that differs from the current machine, updated instructions can be found on our [webpage](#) or by contacting [GreenTec After-sales service](#) department at: [service@greentec.eu](mailto:service@greentec.eu)

## Manufacturer, name, and address (a)

---



Merkurvej 25  
DK-6000 Kolding  
Danmark

Tel: +45 75553644  
Fax: +45 75554243  
E-mail: [info@greentec.eu](mailto:info@greentec.eu)  
Web: [www.greentec.eu](http://www.greentec.eu)

# Preface

---

Dear Customer!

Your new GreenTec machine is designed based on almost 30 years of experience with vehicle-mounted machines for maintaining green areas.

The machine is manufactured based on the latest technology and approved safety regulations, standards, and regulations.

We want to make a product available in a way that does not cause damage or misunderstandings either during use, during transport or during maintenance of the machine.

The user manual contains information and instructions that are important and useful for maintaining the operational safety, reliability, and value of the GreenTec machine.

Therefore, read this user manual carefully, as it will make you familiar with assembly, use, care, and maintenance. **Pay particular attention to instructions regarding safety!**

You are welcome to visit our website [www.greentec.eu](http://www.greentec.eu) - where you can find technical documentation and access the latest updates to instruction- and spare parts books on our entire product range.

We hope that you will be satisfied with your new GreenTec machine!



Kind regards:



**John Christensen**

Co-owner, Product Development  
GreenTec A/S

*GreenTec's vision is to develop and sell quality machines for the maintenance of green areas, i.e., in agriculture, industry, airports and the municipal sector. Through innovative product development, we strive to become a leader in our field.*

*All machines are developed in a simple, functional, and production-friendly design in close cooperation with dealers and end users. It is our goal to cover all needs in the market segment with a minimum of 2 different proposed solutions.*

*Through in-depth analysis and counselling, the customer must be offered the best possible solution, where individual needs can also be met through the modular structure of the product range.*

*The aim is also to offer the best possible after-sales service and a fast and efficient supply of spare parts.*

# Contents

---

(Letters in headings (x) refer to Machinery Regulation (EU) 2023/1230, Paragraph 1.7.4.2, "Contents of the instructions" sections a – u)

Manufacturer, name, and address (a) .....	A
List of tables and figures .....	F
Tables in this instruction manual .....	F
Figures in this instruction manual .....	G
Declaration of conformity (c).....	1
1) Machine data and useful info (b).....	2
1.1) Registration of Greentec machine data .....	2
1.2) Name plate .....	3
1.3) Warranty terms.....	3
1.4) Complaints .....	4
1.5) Use with other manufactures than Greentec .....	4
2) General information .....	5
2.1) Use of the user manual .....	5
2.2) Definitions of information signs .....	5
2.3) Definitions, terms, and descriptions .....	5
3) Safety.....	6
3.1) Local legislation in the country where the machine is used.....	6
3.2) Warnings, prohibitions, and instructions .....	6
3.3) Safety labeling.....	6
3.3.1) Personal safety equipment.....	6
3.3.2) Warning labels.....	7
3.4) Working in publicly accessible places.....	8
3.4.1) Warnings signs in public places.....	8
3.4.2) Use of warnings signs .....	8
3.4.3) Suggested signage when working on public roads .....	9
3.5) Recommendations for optimal security and operation (l) .....	10
3.5.1) Safety distances .....	11
3.5.1.1) Overhead power lines.....	12
3.6) Necessary safety measures (m) .....	13
3.7) Warnings on how the machine must not be used (h).....	14
3.8) Safety instructions for maintenance, adjustment, and inspection (s) .....	15
3.9) Safety instructions for the operator / user .....	15
4) Machine description (d).....	16
4.1) Overview and features.....	16
4.2) Use of the machine .....	18
4.2.1) Intended use of the machine (g).....	18
4.2.2) Application and restrictions of the machine (h) .....	18
4.3) Components of the machine .....	19
4.3.1) Main frame w. central mounting point.....	19

4.3.2)	Oil motor.....	20
4.3.3)	Power-Band belt drive.....	23
4.3.4)	Widia saw blades.....	24
4.3.5)	Branch guides at saw blades.....	25
4.3.6)	Protective guards for saw blades.....	26
4.3.7)	Skid shoe.....	27
4.3.8)	Adapter-kits for mounting.....	28
4.4)	Approved tool carriers and optional equipment (n).....	29
4.5)	Optional equipment.....	30
4.5.1)	Hydraulic quick couplings.....	30
4.5.2)	Mechanical quick-release.....	31
4.5.3)	Oil flow divider (universal).....	32
4.5.4)	Blade rotor (4 pcs.).....	33
4.6)	Specifications.....	34
4.7)	Noise measurement of airborne noise (u).....	35
5)	Instructions for using the machine (k).....	36
5.1)	GreenTec.eu – Explore and learn!.....	36
5.2)	GreenTec.eu – FAQ.....	36
5.3)	Instructions regarding delivery of the machine.....	37
5.3.1)	Transport damage.....	37
5.4)	Instructions for mounting, connection and disconnection (j).....	38
5.4.1)	Preparation of vehicle and operator.....	38
5.4.2)	Preparation of attachment tool.....	39
5.4.3)	Mounting and connection of the machine (i).....	42
5.4.3.1)	Mounting and connection of LRS 2002 Quadsaw on a tool carrier.....	43
5.4.3.2)	Un-mounting and disconnection of LRS 2002 Quadsaw on a tool carrier:.....	47
5.5)	Preparing the machine for use.....	48
5.5.1)	Procedures before start-up and use.....	48
5.5.2)	Training of machine operators before use.....	48
5.5.3)	Stability (o).....	49
5.5.3.1)	Checking the stability:.....	49
5.5.3.2)	Stability can be increased by:.....	50
5.5.3.3)	Factors influencing stability:.....	50
5.5.4)	Initial start-up and commissioning.....	51
5.6)	Operation of the machine (e).....	53
5.6.1)	Operator's workplace (f).....	53
5.6.2)	Transport of attachment tools on a vehicle (p).....	54
5.6.3)	Start of attachment tool.....	55
5.6.4)	Stop of attachment tool.....	56
5.6.5)	Setting and adjusting the machine (r).....	57
5.6.5.1)	Adjusting the branch guides:.....	57
5.6.5.2)	Setting the cutting angle:.....	58

5.6.6)	Driving instructions.....	59
5.6.7)	Start-up after unintended / accidental stoppage (q).....	62
6)	Inspection and maintenance (e, r) .....	63
6.1)	Instructions for safe maintenance and adjustment (s).....	64
6.1.1)	Properly move your GreenTec machine .....	64
6.2)	Daily and routine inspections (e).....	65
6.3)	Tightening of bolts and hydraulic connections .....	67
6.3.1)	Tightening of bolts.....	67
6.3.2)	Tightening of hydraulic hoses- and fittings .....	68
6.4)	Hydraulic hoses.....	69
6.5)	Bearings, shafts, rivets, and bushings.....	70
6.5.1)	Ball bearing w. rubber seals.....	70
6.6)	Checking and adjusting belt tension .....	71
6.6.1)	Checking belt tension.....	71
6.6.2)	Adjusting belt tension.....	73
6.7)	Checking pressure- and flow specifications.....	75
6.7.1)	Correct measurement of pressure and flow .....	75
6.8)	Cleaning the machine.....	76
6.9)	Lubrication of the machine.....	77
6.9.1)	Worn / shiny metal parts.....	77
6.10)	Storage of the machine .....	78
6.11)	Disposal of machine/machine parts .....	78
7)	Troubleshooting the machine .....	79
7.1)	Troubleshooting procedures .....	79
8)	Appendix .....	81
8.1)	Hydraulic diagrams .....	81

# List of tables and figures

---

## Tables in this instruction manual

Table 1 – Machines covered by declaration of conformity.....	1
Table 2 – Declared international standards .....	1
Table 3 – Machine data form .....	2
Table 4 – Content of GreenTec name plate.....	3
Table 5 – Warranty coverage .....	3
Table 6 – Definitions, terms and descriptions.....	5
Table 7 – Overview of equipment.....	17
Table 8 – Data sheet: Oil motors on the LRS 2002 Quadsaw .....	20
Table 9 – Data sheet: Piston motor without overpressure and anti-cavitation valve (50 l/min).....	21
Table 10 – Data sheet: Piston motor with overpressure and anti-cavitation valve (50 l/min) .....	21
Table 11 – Data sheet: Piston motor with overpressure and anti-cavitation valve (85 l/min) .....	22
Table 12 – Data sheet: Gear motor with integrated front bearing (50 l/min).....	22
Table 13 – Data sheet: Power-band belt drive.....	23
Table 14 – Data sheet: Widia saw blades .....	24
Table 15 – Adapter-kits for mounting on tool carrier .....	28
Table 16 – Approved tool carriers and optional equipment.....	29
Table 17 – Data sheet: Hydraulic quick couplings.....	30
Table 18 – Data sheet: Oil flow divider (universal) .....	32
Table 19 – Data sheet: Blade rotor (4 pcs.).....	33
Table 20 – Data sheet: Machine specifications.....	34
Table 21 – Measurement of A-weighted sound power level.....	35
Table 22 – Checklist for delivery of machine .....	37
Table 23 – Assembly of the adapter kit.....	39
Table 24 – Mounting of saw blades.....	39
Table 25 – Adjustment of deflector rail .....	40
Table 26 – Installation of branch guides at saw blades .....	40
Table 27 – Installation of protective guards for saw blades.....	41
Table 28 – Tightening of fittings for hydraulic hoses.....	41
Table 29 – Mounting and connection of LRS 2002 Quadsaw on tool carrier (1/3) .....	43
Table 30 – Mounting and connection of LRS 2002 Quadsaw on tool carrier (2/3) .....	44
Table 31 – Mounting and connection of LRS 2002 Quadsaw on tool carrier (3/3) .....	46
Table 32 – Procedures for initial start-up and commissioning.....	51



Table 33 – Driving instructions: LRS 2002 Quadsaw (1/2) .....	60
Table 34 – Driving instructions: LRS 2002 Quadsaw (2/2) .....	61
Table 35 – Checklist for daily inspections: Before and after commissioning .....	65
Table 36 – Checklist for semi-annual inspection: preventive maintenance .....	66
Table 37 – Tightening torques for bolts .....	67
Table 38 – Tightening torques for hydraulic hoses and fittings .....	68
Table 39 – Belt diagram: LRS 2002 Quadsaw (right/left) .....	72
Table 40 – Measurement of pressure and flow: LRS 2002 Quadsaw .....	75
Table 41 – Overview of the disposal/scrapping of machine parts .....	78
Table 42 – Identifying error / faulty conditions .....	80

## Figures in this instruction manual

Figure 1 – Name plate for GreenTec machine .....	3
Figure 2 – Safety labelling: Personal safety equipment .....	6
Figure 3 – Safety labeling: Warning labels .....	7
Figure 4 – Proposed signage for work on public roads .....	9
Figure 5 – Safety zones: Vehicle/attachment tool .....	11
Figure 6 – Safety zones: Overhead power lines .....	12
Figure 7 – Width and depth: LRS 2002 Quadsaw .....	35
Figure 8 – Height: LRS 2002 Quadsaw .....	35



# Declaration of conformity (c)

## Acc. to Machinery Regulation (EU) 2023/1230 Annex V.A

**MANUFACTURER:** GreenTec A/S  
**ADDRESS:** Merkurvej 25  
**LOCATION:** DK-6000 Kolding



We, **GreenTec A/S**, hereby declare that the machine:

TYPE:	PRODUCT:	APPROVED WITH:
<b>Quadsaw</b>	<b>LRS 2002</b> 9992002R-50A, 9992002R-50AM, 9992002R-50T, 992002R-85A  9992002L-50A, 9992002L-50AM, 9992002L-50T, 992002L-85A	Scorpion 5-630 S - Basic Front Scorpion 5-830 S Scorpion 5-830 PLUS Spider 5-830 PLUS PUMA 3303 Multi Carrier (50 l/min) PUMA 3303 Tele Multi Carrier (50 l/min)  Other manufacturers: Twiga, Twose, McConnel, Bomford, Kuhn, Mulag, Hydrema, Dücker, Universal

Table 1 – Machines covered by declaration of conformity

- is manufactured in conformity with both the European Parliament and Council Regulation (EU) 2023/1230, and UK Statutory Instrument 2008 No. 1597: The Supply of Machinery (Safety) Regulations 2008, with references to the following standards associated with its design, construction, and production:

NAME:	DESCRIPTION:
<b>BS/EN ISO 12100:2011</b>	Safety of machinery - General principles for design - Risk assessment and risk reduction.
<b>BS/EN ISO 14120:2015</b>	Safety of machinery - Guards - General requirements for the design and construction of fixed and movable guards.
<b>BS/EN ISO 4413:2010</b>	Hydraulic fluid power - General rules and safety requirements for systems and their components.

Table 2 – Declared international standards

The declaration only applies if the machines stated above are used in accordance with the operating instructions. When connecting the above-mentioned machines to a vehicle and/or with a tool carrier other than those mentioned above, it is the responsibility of the owner and operator to ensure that the vehicle and the assembled machines meet the applicable requirements in the relevant directives for this.

**Date:** 01.01.2025

**John Christensen**

Co-owner, Product Development  
GreenTec A/S

# 1) Machine data and useful info (b)

Before the machine is put into use for the first time, the dealer is responsible for ensuring that the buyer receives this document and that the machine is correctly registered via the Extranet on GreenTec's website:

<https://extranet.greentec.eu/login>

If in doubt regarding login information, please contact GreenTec After-sales service: [service@greentec.eu](mailto:service@greentec.eu)

The dealer/importer must also ensure that the buyer and operator fully understand the contents before the machine is put into use.

If the machine is re-sold, all the supplied technical documentation must be handed over to the new owner and must also always accompany the machine.

The fields below are filled in, for future use when ordering spare parts or other enquiries:

## 1.1) Registration of Greentec machine data

DATA TO BE ENTERED BY THE DEALER VIA THE GREENTEC EXTRANET!

Machine description:

Serial number:

Sales date:

Dealer:

E-mail:

Phone:

Table 3 – Machine data form



## 1.2) Name plate

All GreenTec's machines are equipped with a name plate.

The nameplate contains important information relating to the machine, including a unique serial number used for identification.

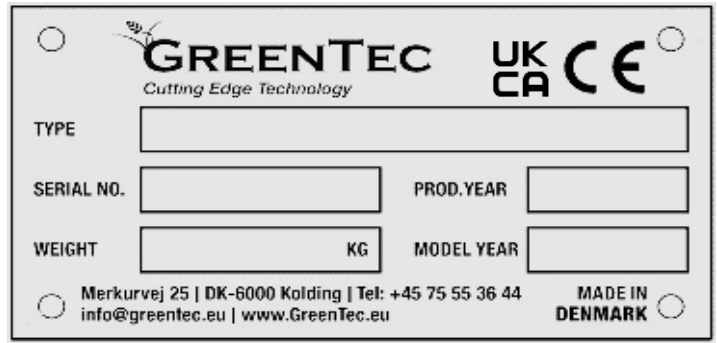

Figure 1 – Name plate for GreenTec machine

CONTENT OF THE NAME PLATE:	
<b>TYPE:</b>	Machine model and type number.
<b>SERIAL NO.:</b>	Unique serial number of the machine.
<b>PROD. YEAR:</b>	Production year.
<b>WEIGHT:</b>	Weight of the machine <i>without</i> optional equipment (kg.)
<b>MODEL YEAR:</b>	The year of development of the machine model.

*The nameplate also provides address information for the manufacturer.*

Table 4 – Content of GreenTec name plate

## 1.3) Warranty terms

- GreenTec must be notified in writing of errors or defects in the sold machine **no later than 8 days** after the error was or should have been registered by the end-user. If not notified within this period, the customer is not entitled to submit claims regarding errors or defects.
- GreenTec is entitled and obliged to remedy all errors and defects within the specified coverage of the product warranty, being able to decide freely whether such remediation must take place in the form of repair or replacement of the defective part(s).
- Warranted parts, can be re-called upon by GreenTec for inspection, if needed. Unless otherwise agreed, warranted parts must be available for return, free of charge, to GreenTec's After-sales service department - **no later than 14 days** after replacement.
- When warranty work is carried out, **always** make sure to have the original invoices for any spare parts used, and timesheets for the labour and working hours available as documentation.

THE WARRANTY COVERS:	THE WARRANTY DOES NOT COVER:
✓ Defective or faulty design and/or materials.	✗ Normal wear and tear.
✓ Improper or faulty workmanship.	✗ Insufficient service and maintenance.
✓ Original GreenTec parts and materials.	✗ Improper use and/or handling of the machine.
<i>GreenTec's warranty obligation is conditioned to the customer documenting that an identified deficiency or fault is not due to any of the above circumstances.</i>	✗ Overloading of the machine and equipment.
<i>GreenTec assumes no liability for any of the mentioned points, including loss of profits, lost earnings, and other consequential financial loss. Please read through GreenTec's overall terms and conditions of sale and delivery here: <a href="https://greentec.eu/about-us/terms-and-conditions-of-sale-and-delivery/">https://greentec.eu/about-us/terms-and-conditions-of-sale-and-delivery/</a></i>	✗ Incorrect installation and/or mounting.
	✗ Use of non-original spare parts and materials.
	✗ Any 3rd party modifications made to the machine.
	✗ Hydraulic- and/or gear oil, lubricants, or any other propellants.
	✗ Compensation for transport or any consequential costs.
	✗ Any damage and defects due to violation of road and/or traffic regulations.

*(Labour costs associated with a warranty are always settled at a fixed standard rate, agreed between GreenTec and our dealers)*

Table 5 – Warranty coverage

## 1.4) Complaints

Risk for the goods is transferred to the customer immediately upon delivery. Complaints about goods must be made in writing and submitted to GreenTec without undue delay and **no later than 8 days after delivery**. If GreenTec has not received a complaint within the mentioned time limit, the customers lose all rights to complain about the quantity and quality of the goods delivered.

GreenTec has the right and obligation to remedy all errors resulting from defective design, materials, and workmanship. GreenTec decides whether the remedy must be in the form of repair or replacement of the defective part(s).

If GreenTec chooses to repair the goods, the customer is obliged to deliver and collect the goods from a workshop indicated by GreenTec, without GreenTec incurring costs in this context.

If GreenTec chooses to replace the defective part(s), customers must send the defective part(s) to GreenTec without GreenTec incurring costs in this regard. Instead, GreenTec is entitled to supply replacement goods.

GreenTec's liability only applies to defects, in connection with the sold goods, which are indicated within 2 years from the delivery date.

GreenTec assumes no responsibility for defects that exceed what is stipulated in this provision. This applies to losses resulting from such a deficiency, including loss of profit, lost earnings, and other financial loss.

## 1.5) Use with other manufactures than Greentec

### **NOTICE**

When installing other makes of attachment tools than GreenTec, a new risk assessment of the equipment used must be submitted.

If the attachment tool is fitted with an unapproved Multi Carrier is, the basis for risk assessment will no longer apply, and thereby the validity and guarantee of the declaration of conformity.

It is every operator's own responsibility to risk assess this interconnection before using the machine.

## 2) General information

### 2.1) Use of the user manual

Read this user manual thoroughly before assembling and putting the machine into use. If you have any questions, contact your local dealer or GreenTec's After-sales service department.

#### **NOTICE**

The illustrations in this user manual have the sole purpose of instructing, informing, and substantiating the general procedures and instructions. Illustrations may appear different from the actual machine, e.g., by being fitted with additional equipment and/or in a different size variant.

### 2.2) Definitions of information signs

The following definitions apply throughout this user manual:

#### **⚠ DANGER**

**DANGER!**  
Warns of a potential situation that could result in death or permanent disabling injury if instructions are not followed carefully!

#### **⚠ WARNING**

**WARNING!**  
Warns of a potential situation that could result in partially disabling injuries or serious bodily injury if the instructions are not followed carefully!

#### **⚠ CAUTION**

**CAUTION!**  
Warns of a potential situation that could result in serious damage to the machine or equipment if the instructions are not followed carefully!

#### **NOTICE**

**NOTICE!**  
Specific or general information deemed important or useful.

### 2.3) Definitions, terms, and descriptions

<b>Operator:</b>	Daily user and/or operator of the machine.
<b>Owner:</b>	Owner, buyer and/or those who are responsible for the operator and maintenance.
<b>Tool carrier:</b>	Multi Carrier, boom mower, support arm / lift arm which controls, handles, and carries attachment tools during operation.
<b>Attachment tool:</b>	Attachment tool that is handled and carried by tool carrier during operation.
<b>Vehicle:</b>	Machine that transports tool carrier + attachment tool during operation.
<b>RH / LH</b>	RH: Right-sided unit / LH: Left-sided unit.

Table 6 – Definitions, terms and descriptions

## 3) Safety

---

### 3.1) Local legislation in the country where the machine is used

The use of the machine may be restricted by the legislation of the countries where it is used. It is important that the responsible owner and operator familiarize themselves with the country's laws and regulations regarding cutting, pruning and maintenance of fences and hedges.

### 3.2) Warnings, prohibitions, and instructions

Instructions come from the applicable national accident prevention regulations, which the operator and operator must comply with:

#### **WARNING**

For all types of work on the machine, it must be disconnected from all hydraulics!

#### **WARNING**

Only authorized personnel may carry out service and maintenance on the machine!

#### **CAUTION**

Read the user manual carefully before using the machine!

### 3.3) Safety labeling

The machine is marked with safety and warning labels, these are placed at the identified dangers to which you are exposed when working with and staying near the machine.

#### 3.3.1) Personal safety equipment

It is recommended that the following safety equipment is worn when working with or performing maintenance on the machine:



Working suit



Safety shoes



Safety glasses



Hearing protection



Safety helmet



Protective gloves

Figure 2 – Safety labelling: Personal safety equipment

The recommended safety equipment together with the points of attention mentioned in this and the following section cover the precautions GreenTec has deemed necessary for use. The varying circumstances that may arise when working with this machine cannot always be predicted.

No good advice can replace "common sense", "due care" and "attention", but the above recommendations are a good start to safe use of the GreenTec machine.



### 3.3.2) Warning labels

Warning labels that identify the dangers to which you are exposed when working with and when staying near the machine:

**WARNING LABELS:**

	<b>Warning!</b> Read relevant instruction manuals carefully before using this machine.		<b>Warning!</b> Always pay attention to overhead lines! Between the electricity masts, there will always be a risk of touching the overhead lines.
	Follow all instructions and safety regulations when using the machine.		If in doubt - contact the local electricity company for instructions on safety distance.
	<b>Warning!</b> Check every 8 hours of use that all bolts/nuts are tight.		<b>Warning!</b> Beware of oil in case of skin contact or inhalation of oil vapors, as well as high pressure in case of leakage or handling.
			Switch off the engine, remove the key and apply the handbrake before maintenance or repair work.
	<b>Warning!</b> Flying objects/material. Make sure to keep a distance from the machine during use.		<b>Warning!</b> Rotating saw blades/knives! Keep away from the saw blades/knives during use.
			Never remove protective screens/caps!

Figure 3 – Safety labeling: Warning labels

### 3.4) Working in publicly accessible places

When working in publicly accessible places, such as roadsides, consideration must be given to the presence of others in the area.

Immediately stop the machinery when, for example, pedestrians, cyclists, horse riders etc. approach the safety zone. Only resume work when they are at a safe distance again.

When the machine is used on public roads, applicable traffic laws must be observed in every event.

#### 3.4.1) Warnings signs in public places

- The work area should be marked with appropriate signage, this is a legal requirement in public places.
- Signage must be clear and correctly placed so that the danger is made clear.
- Contact the local road authority for detailed information on applicable legislation.
- The local road authority should be notified before work begins on a public road.

#### 3.4.2) Use of warnings signs

- On two-way roads, signage must occur in both directions.
- The work should be within 1 km of signage.
- Only carry out work when visibility is good and when the risk is the least – e.g., outside rush hour.
- The vehicle must be equipped with flashing orange light beams.
- Vehicles should be in a conspicuous colour and the operator should be wearing visible clothing.
- Remaining material should be removed from the road and pavement as soon as practicable and at suitable intervals.
- The work must be carried out before warning signs are removed.
- Collect all road signs as soon as the work is completed.

### 3.4.3) Suggested signage when working on public roads

	<b>Mandatory sign:</b>
	"Keep left"  White and blue arrow signage. Visibly marked on the back of the machine.
	<b>Warning sign:</b>
	"Road work"  Supplementary text for work carried out at a suitable distance.  Example: "Verge cutting 0-1 km"
	<b>Warning sign:</b>
	"Road narrowing"  Adding text: "One lane only"

Figure 4 – Proposed signage for work on public roads

## **NOTICE**

The above signage applies within i.e., EU mainland, where traffic passes on the left of the machine working in the direction of travel.

Signage, use of and colours on arrow signs as well as indications depend on the language, laws, and regulations of the individual country.

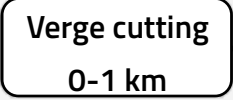
### 3.5) Recommendations for optimal security and operation (I)

#### **⚠ DANGER**

Always be aware of the following risks when using the machine:

**This machine can be potentially fatal in the wrong hands. It is therefore of the utmost importance that both the owner of the machine and the machine operator fully understand the following, to ensure that they are aware of the dangers that exist or may arise when using the machine, as well as which responsibility that comes with the use of the machine.**

**The operator of this machine has, in addition to the responsibility for himself, also responsibility for others who may enter the proximity of the machine; as the owner is responsible for both the operator and others who may come near the machine.**

To achieve optimal safety and operation, it is important that the operator understands how dangerous the machine is, and foresees the danger before it occurs:

- ⚠** You may get stuck when the machinery is engaged or disengaged and when the lift arm system or the tool carrier is moved out or in, up or down and forwards or backwards.
- ⚠** The machinery can tip over when the lift arm system or tool carrier is raised.
- ⚠** You can be caught by the rotating shaft from the PTO.
- ⚠** You can be hit or caught by the moving parts, e.g., flails, blades, knives, drive shaft and wings from mounted attachment tools, or hit by flying materials or machine parts in case of machine damage.
- ⚠** The attachment tools are powered by hydraulic oil from the hydraulic system in the machine or from the vehicle.
- ⚠** The operator of the vehicle should know how the hydraulic oil should be handled! (Read in the safety data sheet for the oil)
- ⚠** Oil splashes under high pressure from damaged fittings or hydraulic hoses can penetrate the skin and cause serious injury.
- ⚠** Accidents due to collisions with other vehicles or dropped objects on the road.

### 3.5.1) Safety distances

When using the machinery, there is a risk that the attachment tool may throw flying objects-/material. Depending on the driving conditions and surface, there will be the possibility that serious fragments can come flying and damage people or equipment.

- Always comply with the specified safety distances (SDF/SDR) to the machinery.

When using the machinery there is a risk of being hit or caught by the moving parts, e.g. flails, blades, knives, drive shaft and wings from mounted attachment tools, as well as being hit by flying materials or machine parts in the event of machine damage.

- Always comply with the specified safety radius (SR) for the machinery.



During commissioning, persons must **under no circumstances** enter the safety zones marked on the drawings!

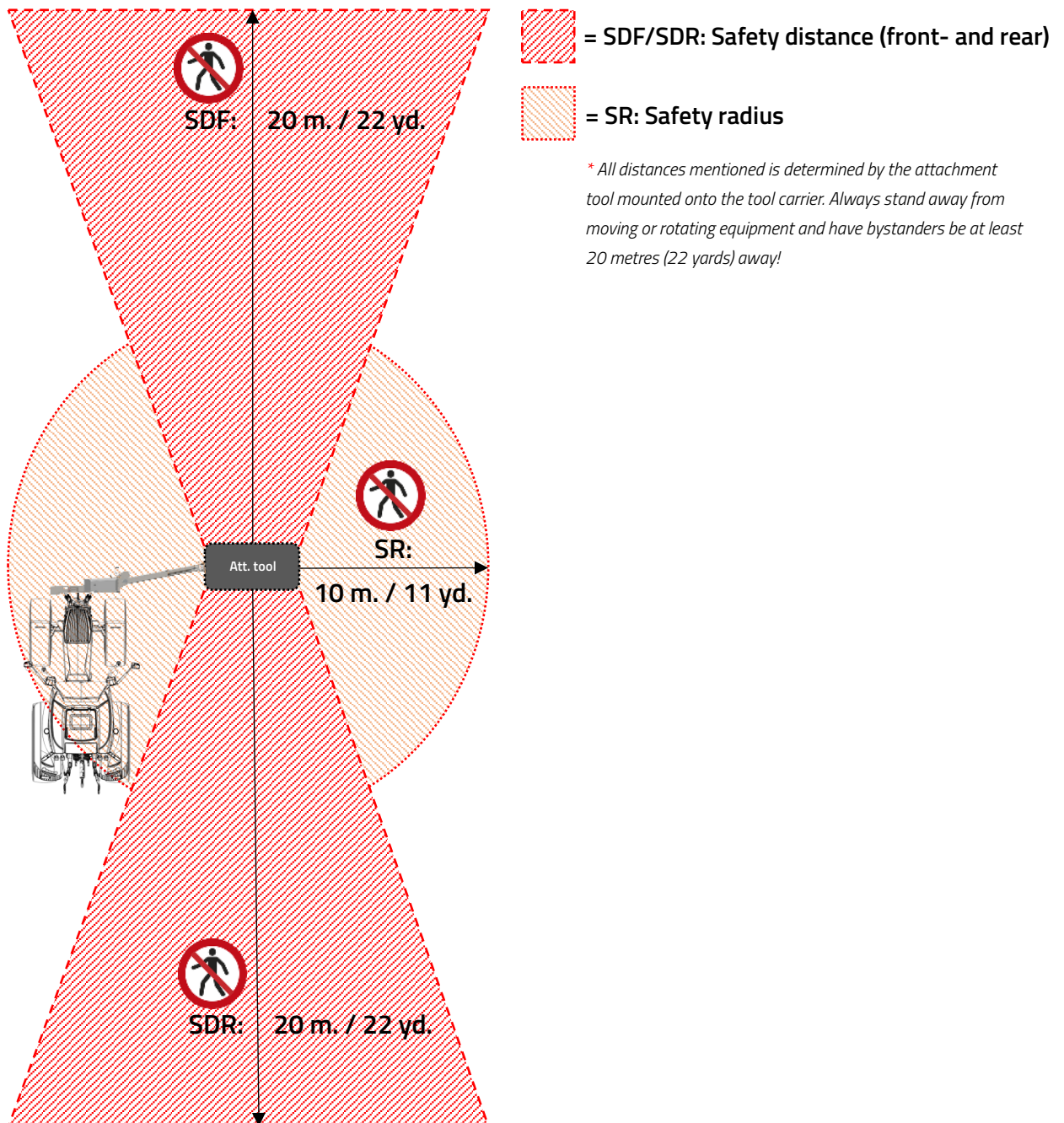

Figure 5 – Safety zones: Vehicle/attachment tool

### 3.5.1.1) Overhead power lines

**Always** pay attention to overhead power lines and work at a safe distance from them! Between electricity masts, there will always be a risk of touching the overhead lines. A safe working distance depends on the voltage of the power lines. **Always observe the specified minimum safety distance!**

The higher the voltage, the greater the distance required between the power lines and the machinery! When in doubt – always contact the local power company for safety instructions!



## NOTICE

The safety instructions comply with the instructions of applicable international organizations and legal requirements in various decrees on safety for carrying out work in the vicinity of electrical installations → Sikkerhedsstyrelsen (DK), HSE (UK), BAuA (DE) and OSHA (US).

## DANGER

**During commissioning, persons, machinery, tools and other materials must under no circumstances come within the grey area marked on the drawings!**

## CAUTION

The safety distances do not apply to agricultural machinery if the total machinery incl. its driver does not exceed a height of 4 m./13 ft. in the case of low-voltage electrical installations and 4.5 m./14.75 ft. in the case of high-voltage electrical installations.

**If the agricultural machinery is higher than this, the following safety distances must always be observed!**

#### Low voltage overhead lines\* (0 – 0,4 kV)

Horizontal distance: **1,5 m. / 5 ft.**  
Vertical distance: **3 m. / 10 ft.**

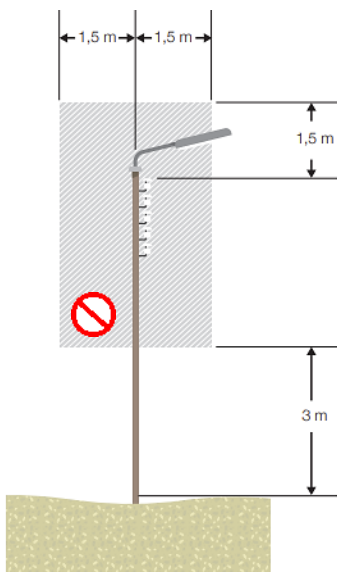

\* In the case of low-voltage overhead lines, work can be done above the masts by observing a safety distance of 1.5 m. / 5 ft.

#### High voltage overhead lines (10 – 40 kV)

Horizontal distance: **6 m. / 20 ft.**  
Vertical distance: **3 m. / 10 ft.**

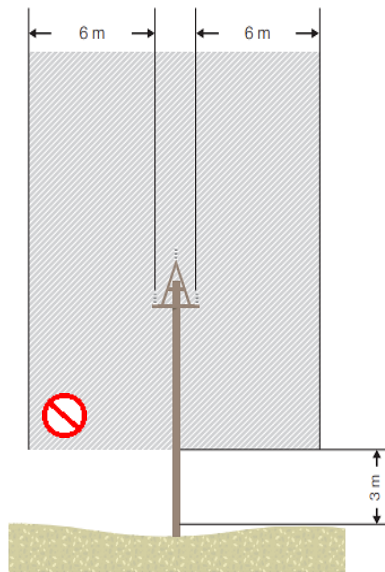

#### High voltage overhead lines\* (40 – 400 kV)

Horizontal distance: **15 m. / 50 ft.**  
Vertical distance: **3 m. / 10 ft.**

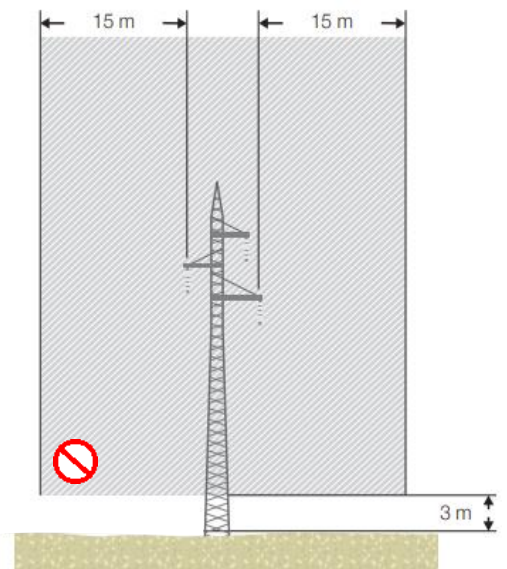

\* At a higher voltage than +400 kV: Safety distance must be determined by the network owner/operating manager or registered professional engineer.

Figure 6 – Safety zones: Overhead power lines

### 3.6) Necessary safety measures (m)

## NOTICE

The machine must be used in the following ways:

- ✓ Make sure that the operator of the machine has read this user manual, as well as the user manuals for both the attachment tool and the vehicle used.
- ✓ Ensure that the operator of the machine has been trained in the use of the machine.
- ✓ Use hearing protection if the machine is operated from a cabin that is not soundproof or if the cabin windows are open.
- ✓ Ensure that all warning labels are always visible and that none of them are missing, damaged or illegible.
- ✓ Check that all safety screens are correctly fitted and that there are no damaged or loose parts.
- ✓ Ensure that all hydraulic pipes and hoses are positioned correctly to avoid rubbing, stretching, pinching, or kinking damage to them.
- ✓ Check the work area and remove any rope, poles, large stones, and other dangerous objects before starting work.
- ✓ Drive at a safe speed that is tailored to the terrain and any other vehicles and obstacles.
- ✓ Make sure the vehicle is stable and meets the machine manufacturer's minimum weight recommendations - if necessary, use additional counterweight.
- ✓ Pay attention to power lines, if in doubt about the distance, contact the local power plant.
- ✓ It is recommended to use impact resistant screens on the vehicle.
- ✓ Check that the machine's fittings, screws, and couplings are in good condition.
- ✓ Follow the manufacturer's instructions for removing and installing the machine from the vehicle.
- ✓ Disconnect the hydraulics to the machine, stop the engine, pull the handbrake, and remove the key before leaving the cab.
- ✓ If necessary, remove nuisance material residues left behind from the area.
- ✓ Great care must be taken when inspecting, repairing, or doing other work on the stationary machine.
- ✓ Always use protective gloves, safety shoes, safety glasses and appropriate tools to perform the work.

### 3.7) Warnings on how the machine must not be used (h)

#### **⚠ DANGER**

The machine must never be used in the following ways:







- ✗ Do not operate the machine until relevant user manuals have been read and understood. Likewise, the operator must be familiar with the operating levers according to the user manual for the connected attachment tool!
- ✗ Do not operate the machine if there are others within the safety distances of the machine!
- ✗ Never let an inexperienced person operate the machine without supervision!
- ✗ Do not go inside the machine's working area / safety zone!
- ✗ Never try to locate a hydraulic leak by hand, use a piece of cardboard instead!
- ✗ Never allow children to play on or near the machine!
- ✗ Do not perform any maintenance or adjustment without first removing the hydraulic pressure from the machinery, lowering the tool carrier to the ground, stopping the vehicle engine, and applying the parking brake and removing the key!
- ✗ Do not use and/or mount the machine on a vehicle that does not comply with the manufacturer's specifications!
- ✗ Never use the machine if the hydraulic system shows signs of damage / defects!
- ✗ Do not stop the engine while the hydraulic pressure is activated!
- ✗ Never attempt to use the machine for any purpose other than that for which it is intended!
- ✗ Do not leave the vehicle cabin without removing the ignition key!
- ✗ Do not transport the machine while the hydraulic pressure to the attachment tool is activated!
- ✗ Do not use a machine that has not been maintained or if any of its screens are missing or damaged!
- ✗ Never operate the vehicle or any of the control levers from a position other than the driver's seat!
- ✗ Do not drive with mounted attachment tools where rotating parts are facing the cabin, as this entails the risk of stones and material residues being hurled at the driver!









### 3.8) Safety instructions for maintenance, adjustment, and inspection (s)

#### **NOTICE**

The machine must be maintained in the following ways:

-  The operator must ensure that all maintenance, inspection, and assembly work is carried out by authorized and qualified specialist personnel who, after thorough reading of relevant instruction materials, possess sufficient knowledge.
-  Maintenance, inspection, and assembly work may only be carried out with the hydraulics disconnected.
-  When carrying out maintenance work under the machinery etc., securing with suitable support elements must be carried out.
-  When replacing attachment tools, the hydraulic system is checked for residual pressure. A possible residual pressure is reduced to zero (0 bar / 0 psi).
-  Use only suitable tools and wear heavy-duty gloves, safety shoes and safety glasses.
-  Handle the hydraulic oil and grease according to regulations. Always be familiar with the safety data sheets.
-  Immediately after finishing work, all safety and protective devices must be installed and activated again.

### 3.9) Safety instructions for the operator / user

-  It is important to familiarize yourself with all operating elements and equipment and their function before starting the work. Once the work has started, it may be too late.
-  Check the immediate area before starting and during operation of the work the machine is to perform (people, children, animals, or obstacles, e.g., stones, fence posts, steel wire).
-  Ensure sufficient visibility and a well-lit work area. The safety distances specified in the attachment tool's user manual must be followed without fail.
-  The operator must be fresh and rested before using the machine, and take breaks when tired, to ensure his own safety and that of others.
-  The operator should ensure varying working positions and take frequent breaks to avoid disorders in the musculoskeletal system.
-  The operator must not leave the driver's seat while driving, and it is not permitted to have the attachment tool, or the Multi Carrier activated during transport.
-  When working near high-voltage lines, additional distance and caution are required.

## 4) Machine description (d)

### 4.1) Overview and features



#### 9992002R

LRS 2002 QUADSAW  
RIGHT  
50 L/MIN @ MAX. 180 BAR  
85 L/MIN @ MIN. 150 BAR



#### 9992002L

LRS 2002 QUADSAW  
LEFT  
50 L/MIN @ MAX. 180 BAR  
85 L/MIN @ MIN. 150 BAR

GreenTec LRS 2002 Quadsaw (right- and left-sided model)



**2.0 m**

Vertical working width



**< 16 cm**

Max. branch thickness



**5 km/h**

Max. driving speed



**2-year warranty**

High quality materials = long life

The LRS 2002 Quadsaw is used by farmers, municipalities and contractors all over the world to trim hedges in fields to maintain the effect of the windbreak, protecting crops from the damage caused by strong winds and erosion. The Quadsaw is also suitable for maintaining forest areas where branches overhang paths or roads.

The Quadsaw is hydraulically driven and can be mounted on large and medium-sized vehicles, such as telehandlers, front loaders, tractors and excavators.

A compact and powerful attachment tool with **4x Ø49 (19.29") saw blades, 2.0 m (6'6") working width** and a **low net weight of 198 kg (437 lbs.)**.

It is characterized by a perfect cut, both for thinner twigs and **branches up to 16 cm (6.30") in thickness**.

When mounting the LRS 2002 Quadsaw on a tool carrier for ex. a telehandler, a forward **speed of up to 5 km/h (3 mph)** can be maintained.

#### Perfect cutting quality

Smooth cut of thick and thin branches

#### Top performance

High efficiency and low power requirement

#### Strong build

Long life and minimal maintenance

#### EQUIPMENT OVERVIEW:

Saw blades w. Widia-teeth (4 x Ø49)	✓ Standard
Oil motor (50 l/min @ max. 180 bar or 85 l/min @ min. 150 bar)	✓ Standard
Belt tensioner	✓ Standard
Power-Band belt drive	✓ Standard
OPTIKRIK belt tension meter	✓ Standard
Large smooth surface	✓ Standard
Slim body	✓ Standard
Branch guides for all saw blades	✓ Standard
7° overlap between the blades	✓ Standard
Skid shoe	✓ Standard
Hydraulic quick couplings *	⊖ Option
Mechanical quick-release *	⊖ Option
Oil flow divider	⊖ Option
Blade rotor (4 pcs.)	⊖ Option

\* Only available as optional equipment with Scorpion 5-830 S/PLUS and/or Spider 5-830 PLUS.

Table 7 – Overview of equipment

## NOTICE

See the section in the instruction manual about [optional equipment](#) – page 30–33, and get more information about the different options for the machine on GreenTec's [webpage](#).

## 4.2) Use of the machine

### 4.2.1) Intended use of the machine (g)

#### **NOTICE**

For any use of the machine other than that described in this section, GreenTec is not liable for damages as a result. The risk then rests solely with the operator and/or the user.

The LRS Quadsaw is available in several different sizes, but they all have the same basic construction and operation and are therefore the same. The machine is used to carry out the work of cutting or pruning fence- and/or -hedgerows.

See the machine specifications for tool carriers intended for use with the LRS 2002 Quadsaw.

([Specifications](#) – page 34)

### 4.2.2) Application and restrictions of the machine (h)

The LRS 2002 Quadsaw can, in combination with a tool carrier, be front or rear mounted on a wide variety of large and medium-sized vehicles, such as telehandlers, front loaders, tractors and excavators.

The minimum vehicle weight depends on the model and size of the tool carrier/attachment tool combination, and for the LRS 2002 Quadsaw can vary from minimum 5,000 kg to up over 8,000 kg (11.023 lbs. to up over 17.637 lbs), depending on the tool carrier model.

GreenTec designs many different types of suspensions, loader brackets and adapters for many different vehicles.

The capacity of the machine depends on the specifications of the attachment tool used, the hydraulic pressure it is supplied with, the type and amount of material to be processed and the speed at which it is driven.

#### **⚠ DANGER**

**The owner of the machine / operations manager is responsible for observing the following rules:**

- The vehicle on which the machine is mounted must meet the requirements for machines approved for agriculture.
- All safety values must under no circumstances be exceeded. (Safety distances, pressure, flow, rpm, etc.)
- Never use the machine with an attachment tool without fitted guards.
- The machine must never be used to transport people, animals or other equipment than described in this instruction manual. The tool carrier and/or attachment tool must never be used as a "crane" or other form of lifting equipment.
- That the stability of the supporting vehicle is sufficient. See section: [Stability \(o\)](#) – page 49-50, as well as the instruction manual for the tool carrier and vehicle used.

#### **⚠ DANGER**

**Safety shields on the used attachment tool can never work 100%!  
Depending on the driving conditions, there will be a possibility that serious fragments/material can come flying and damage people or equipment.  
Always keep your distance!**

## 4.3) Components of the machine

### 4.3.1) Main frame w. central mounting point

The LRS 2002 Quadsaw main frame is made of solid steel elements and has a working width of 2.0 meters (6.56 ft.) including saw blades.

The machine is designed so that the mounting point for the tool carrier is located centrally on the Quadsaw's main frame.

There are various options for mounting to different tool carriers, using a large selection of adapter brackets. Adapter brackets for tool carriers are easily mounted on the main frame of the Quadsaw using the corresponding bolts/nuts. See section:

[Preparation of attachment tool](#) – page 39.

Depending on the configuration with the tool carrier, the operator has the option to adjust and angle the Quadsaw both vertically and horizontally, so that the best possible cutting result can be achieved, in relation to the material with which the machine is to work.

### NOTICE

The LRS 2002 Quadsaw is recommended to be angled vertically with an offset of approximately 250 mm (9.84") between the upper and lower saw blades. This ensures that the Quadsaw meets the material in the best possible way and the optimal cutting result is achieved. See section: [Driving instructions](#) – page 59-61.



Main frame w/ central mounting point



250 mm

250 mm

Displacement / angulation in the vertical direction

### 4.3.2) Oil motor

The LRS 2002 Quadsaw is built either with a piston motor or a gear motor in various configurations. The size and type of the oil motor will vary depending on the combination of Quadsaw and tool carrier.

Common to all motor configurations on the Quadsaw is that the motor either receives oil directly from the vehicle's double-acting outlet through an oil flow divider, or from the tool carrier's own hydraulic system, which thereby drives the belt drive and saw blades at 3200 RPM.

Connecting is done using 1 x DA outlet, **pressure** and **return** incl. an external **drain** connection for all piston motor configurations.

#### ⚠ CAUTION

**Exceeding the recommended oil flow and pressure voids the machine's risk assessment and thus the warranty.**

It is the operator's responsibility to ensure that both inlet pressure, return pressure and the external drain connection are within recommended [specifications](#) – page 34.

See section: [Mounting and connection of the machine \(i\)](#) – page 42-47.



Hydraulic piston motor on LRS 2002 Quadsaw

Below are listed the different configurations of motor types available for the LRS 2002 Quadsaw:

OIL MOTORS: LRS 2002 QUADSAW	
9992002L-50: 9992002R-50:	15 cm <sup>3</sup> piston motor <b>without</b> overpressure and anti-cavitation valve.
9992002L-50A: 9992002-50A:	15 cm <sup>3</sup> piston motor <b>with</b> overpressure and anti-cavitation valve.
9992002L-85A: 9992002-85A:	28 cm <sup>3</sup> piston motor <b>with</b> overpressure and anti-cavitation valve.
9992002L-50T: 9992002R-50T:	14,5 cm <sup>3</sup> gear motor with integrated front bearing.

Table 8 – Data sheet: Oil motors on the LRS 2002 Quadsaw

**DATA: PISTON MOTOR WITHOUT OVERPRESSURE AND ANTI-CAVITATION VALVE (50 L/MIN)**

Type:	Piston motor <b>without</b> overpressure and anti-cavitation valve.
Displacement	15 cm <sup>3</sup> (0.92 in <sup>3</sup> )
Rotation:	Bi-directional w/ external drain connection.
Operating pressure (continuous):	Max. 180 bar @ 50 l/min (Max. 2611 psi @ 13.21 gpm) *
• Recommended return pressure (continuous):	5 bar (72.52 psi) *
• Max. allowed return pressure (peak):	15 bar (217.55 psi) *
• Max. allowed drain pressure (peak):	2 bar (29 psi) *
Torque (rotational force):	50 Nm (36.88 lbf·ft)
Seals type:	NBR
Operating temperature:	-20... +85 °C (-15... +185 °F)
Required contamination class:	ISO 4406: 20/18/15

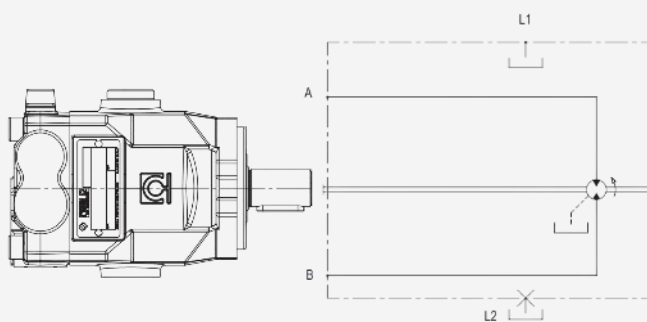

\* Pay particular attention to the performance of the vehicle's double-acting outlet and connection of the external drain connection. The recommended specifications for return and drain pressure on the hydraulic motor cannot be exceeded.

It can result in serious damage to the motor if the regulations for oil flow and pressure are not strictly followed.

Table 9 – Data sheet: Piston motor without overpressure and anti-cavitation valve (50 l/min)

**DATA: PISTON MOTOR WITH OVERPRESSURE AND ANTI-CAVITATION VALVE (50 L/MIN)**

Type:	Piston motor <b>with</b> overpressure and anti-cavitation valve.
Displacement	15 cm <sup>3</sup> (0.92 in <sup>3</sup> )
Rotation:	Bi-directional w/ external drain connection.
Operating pressure (continuous):	Min. 180 bar @ 50 l/min (Min. 2611 psi @ 13.21 gpm) *
• Recommended return pressure (continuous):	5 bar (72.52 psi) *
• Max. allowed return pressure (peak):	15 bar (217.55 psi) *
• Max. allowed drain pressure (peak):	2 bar (29 psi) *
Torque (rotational force):	50 Nm (36.88 lbf·ft)
Seals type:	NBR
Operating temperature:	-20... +85 °C (-15... +185 °F)
Required contamination class:	ISO 4406: 20/18/15

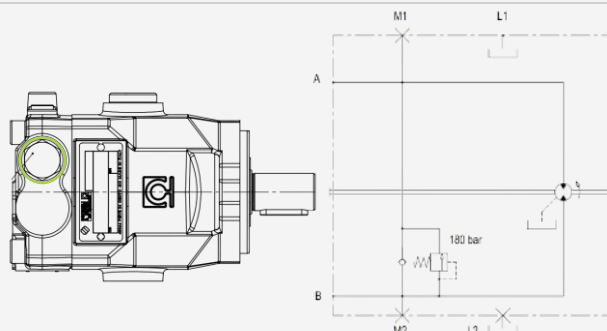

\* Pay particular attention to the performance of the vehicle's double-acting outlet and connection of the external drain connection. The recommended specifications for return and drain pressure on the hydraulic motor cannot be exceeded.

It can result in serious damage to the motor if the regulations for oil flow and pressure are not strictly followed.

Table 10 – Data sheet: Piston motor with overpressure and anti-cavitation valve (50 l/min)

**DATA: PISTON MOTOR WITH OVERPRESSURE AND ANTI-CAVITATION VALVE (85 L/MIN)**

Type:	Piston motor <b>with</b> overpressure and anti-cavitation valve.
Displacement	28 cm <sup>3</sup> (1.71 in <sup>3</sup> )
Rotation:	Bi-directional w/ external drain connection.
Operating pressure (continuous):	Min. 150 bar @ 85 l/min (Max. 2176 psi @ 22.46 gpm) *
• Recommended return pressure (continuous):	5 bar (72.52 psi) *
• Max. allowed return pressure (peak):	15 bar (217.55 psi) *
• Max. allowed drain pressure (peak):	2 bar (29 psi) *
Torque (rotational force):	75 Nm (55.32 lbf·ft)
Seals type:	NBR
Operating temperature:	-20... +85 °C (-15... +185 °F)
Required contamination class:	ISO 4406: 20/18/15

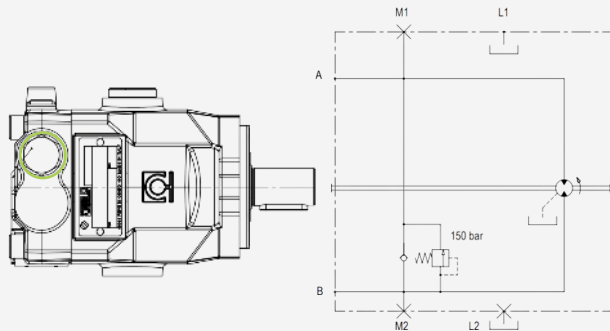

\* Pay particular attention to the performance of the vehicle's double-acting outlet and connection of the external drain connection. The recommended specifications for return and drain pressure on the hydraulic motor cannot be exceeded. It can result in serious damage to the motor if the regulations for oil flow and pressure are not strictly followed.

Table 11 – Data sheet: Piston motor with overpressure and anti-cavitation valve (85 l/min)

**DATA: GEAR MOTOR WITH INTEGRATED FRONT BEARING (50 L/MIN)**

Type:	Gear motor with integrated front bearing.
Displacement	14.5 cm <sup>3</sup> (0.89 in <sup>3</sup> )
Rotation:	Right: clockwise / Left: counter-clockwise. (Both without external drain connection)
Operating pressure (continuous):	Min. 180 bar @ 50 l/min (Min. 2611 psi @ 13.21 gpm) *
• Recommended return pressure (continuous):	5 bar (72.52 psi) *
• Max. allowed return pressure (peak):	15 bar (217.55 psi) *
Torque (rotational force):	50 Nm (36.88 lbf·ft)
Seals type:	NBR
Operating temperature:	-20... +85 °C (-15... +185 °F)
Required contamination class:	ISO 4406: 20/18/15

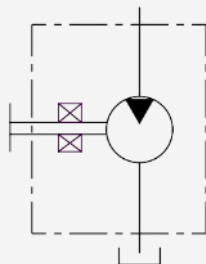
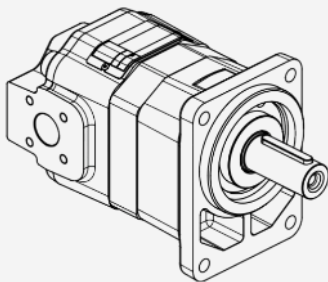

\* Pay particular attention to the performance of the vehicle's double-acting outlet. The recommended specifications, especially for the return pressure of the hydraulic motor, must not be exceeded. Failure to strictly follow the oil flow and pressure specifications can result in serious damage to the motor.

Table 12 – Data sheet: Gear motor with integrated front bearing (50 l/min)



### 4.3.3) Power-Band belt drive

The Power-Band belt drive on the LRS 2002 Quadsaw ensures the power transmission between the oil motor and the saw blades.

The belt drive is symmetrically constructed with a belt drive at the motor shaft, 4x pulleys at each saw blade including 2x belt tensioners to keep the belts tensioned in their path.

The pulley diameters provide a suitable speed ratio, and together with the belts, ensures a good friction-to-force transfer with a high transmission capacity.

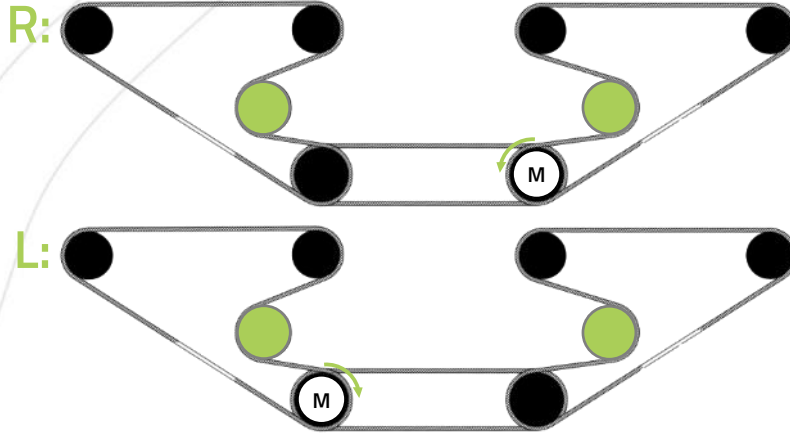

Power-band belt drive on LRS 2002 Quadsaw

## NOTICE

It is important that the belts are inspected regularly and that they are tightened correctly. See section: [Checking and adjusting belt tension](#) – page 71.

#### DATA: POWER-BAND BELT DRIVE

<b>Belt type (profile):</b>	Optibelt PK
<b>Belt lengths:</b>	-
• Belts for saw blades (2x):	2324 mm (91.50")
• Belt for motor:	1422 mm (55.98")
<b>Belt height:</b>	4,60 mm (0.18")
<b>Belt width:</b>	28 mm (1.10")
<b>Rib spacing:</b>	3,56 mm (0.14")
<b>Number of ribs:</b>	6
<b>Belt pulley diameter:</b>	-
• Belt pulleys for saw blades (4x):	133 mm (5.24")
• Belt pulley for motor:	133 mm (5.24")

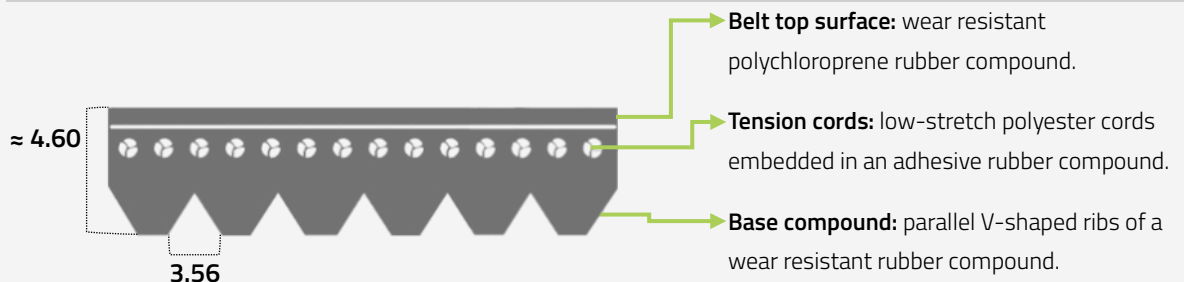

Table 13 – Data sheet: Power-band belt drive

#### 4.3.4) Widia saw blades

The LRS 2002 Quadsaw has 4x saw blades made of carbon steel, fitted with tungsten carbide teeth.

The saw blades are made in HQ-quality, which differs from standard quality saw blades: less noise, low heating, less vibration and twisting of the blade during cutting.

The saw blades cut in downward rotation towards the surface of the ground, so that the saw teeth cut into the material first.

The angle of attack on the saw teeth is in the  $-10^\circ$  negative direction, which ensures a fast and aggressive cut, but which is still clean and precise without splintering the material.

The saw blades on the LRS 2002 Quadsaw must run at a recommended speed of 3200 RPM. The speed of the saw blades is proportional to the Quadsaw's recommended oil flow



Saw blades with Widia teeth



\* If the RPM and material thickness for the blade rotors are exceeded, the machine's risk assessment and thus the warranty will be void.



When handling the saw blades, there is a risk of injury due to the very sharp edges. Recommended safety equipment must always be used!  
See section: [Personal safety equipment](#) – page 6.

#### DATA: SAW BLADES

<b>Diameter (outer):</b>	490 mm (19.29")
<b>Cutting width:</b>	4,00 mm (0.16")
<b>Blade thickness:</b>	3,00 mm (0.12")
<b>Hole diameter (inner):</b>	80 mm (3.15")
<b>Max. branch thickness:</b>	< 16 cm. (6.30")
<b>Max. speed:</b>	3200 RPM
<b>Number of teeth:</b>	72 per blade
• <b>Tooth length:</b>	10,50 mm (0.42")
• <b>Tooth width:</b>	2,30 mm (0.09")
• <b>Tooth material:</b>	HW (Tungsten Carbide) *
• <b>Tooth quality:</b>	K10 *

\* Cf.: ISO 513:2012.

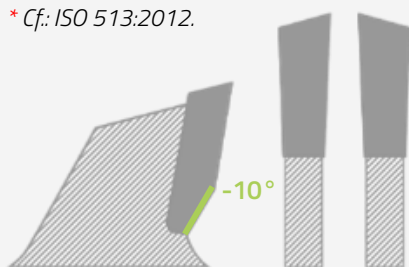

#### Alternate top bevel:

The teeth on the saw blades are chamfered alternately to the left and right.

When the tooth edge is slanted and the direction of each tooth changes from left to right, the material is prevented from splintering and a cleaner cut is achieved.

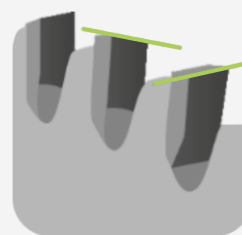

Table 14 – Data sheet: Widia saw blades

### 4.3.5) Branch guides at saw blades

Branch guides at each saw blades (4x), leads the material directly towards the teeth of the blades, and also provides an even intake of material at each saw blade.

The branch guides work together with a deflector rail, that makes sure that any cut material is deflected away from the saw blades, once the material is cut.

The deflector rail have a flush fit along the saw blades, which protects from any material getting around the back side of the saw blades.

## NOTICE

Branch guides and deflector rail is to be adjusted and checked before use of the machine.

See section: [Preparation of attachment tool](#) – page 39-41.



Branch guides at each saw blade

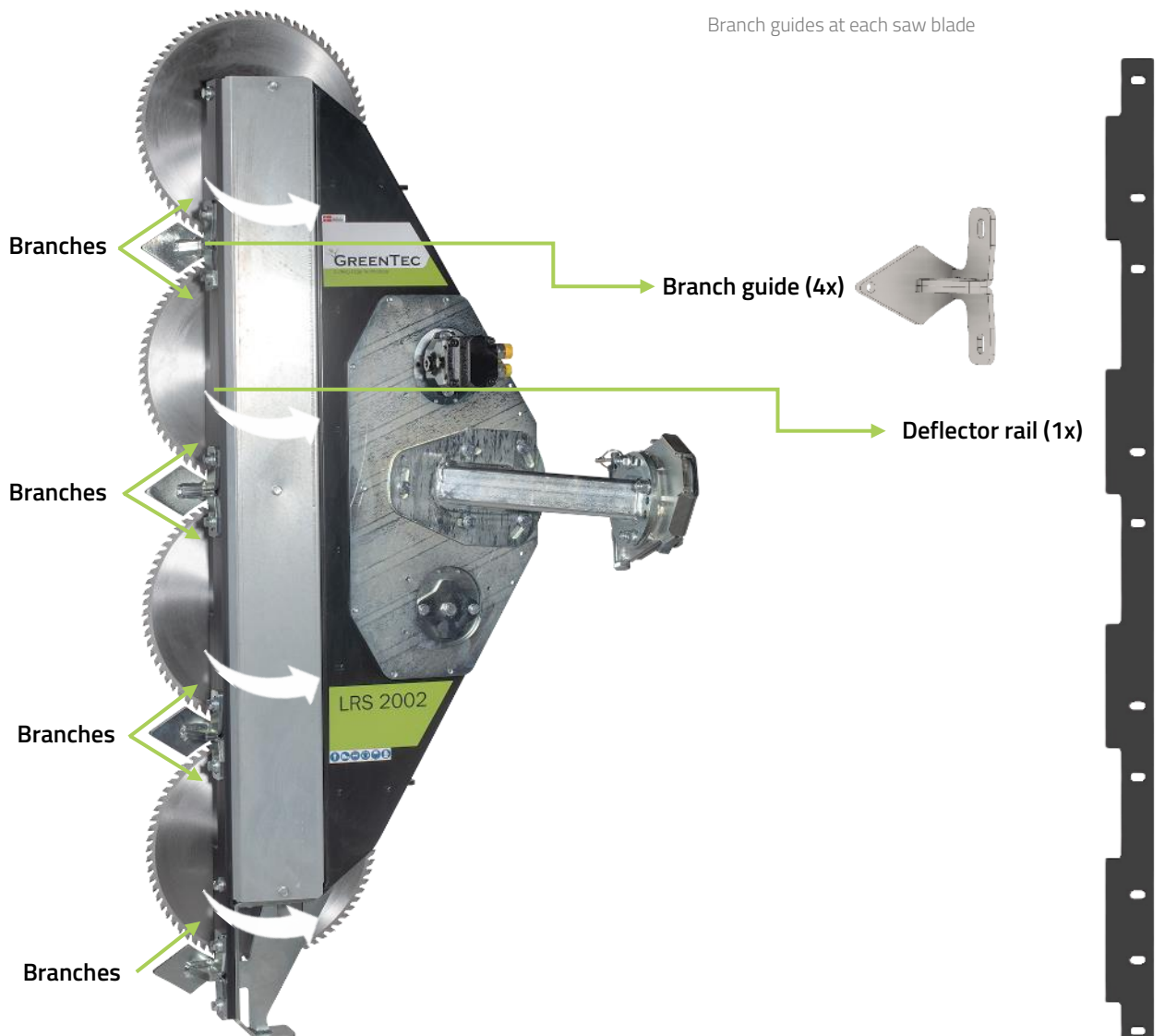

Function of branch guides and deflector rail

### 4.3.6) Protective guards for saw blades

The protective guards at the saw blades ensures that the blades do not take damage / causes damage during storage or transport of the machinery.

Especially during transport of the machinery, the protective guards is used as a traffic safety measure.

The protective guards are double-sided, and made of solid steel and has a black/yellow warning marking along the entire surface that draws attention to the dangerous area of the machine.

The protective guards are mounted on to the Quadsaw, using 4x lynch pins clamping the protective guards around the saw blades.

#### **⚠ WARNING**

The accompanying safety devices must always be installed when storing and transporting all types of GreenTec attachment tools. (Safety shielding, locking mechanisms, etc.)

Likewise, it must always be attempted to turn attachment tools away from other traffic.

See section: [Transport of attachment tool on a vehicle \(p\)](#) – page 54.



Protective guards mounted around saw blades

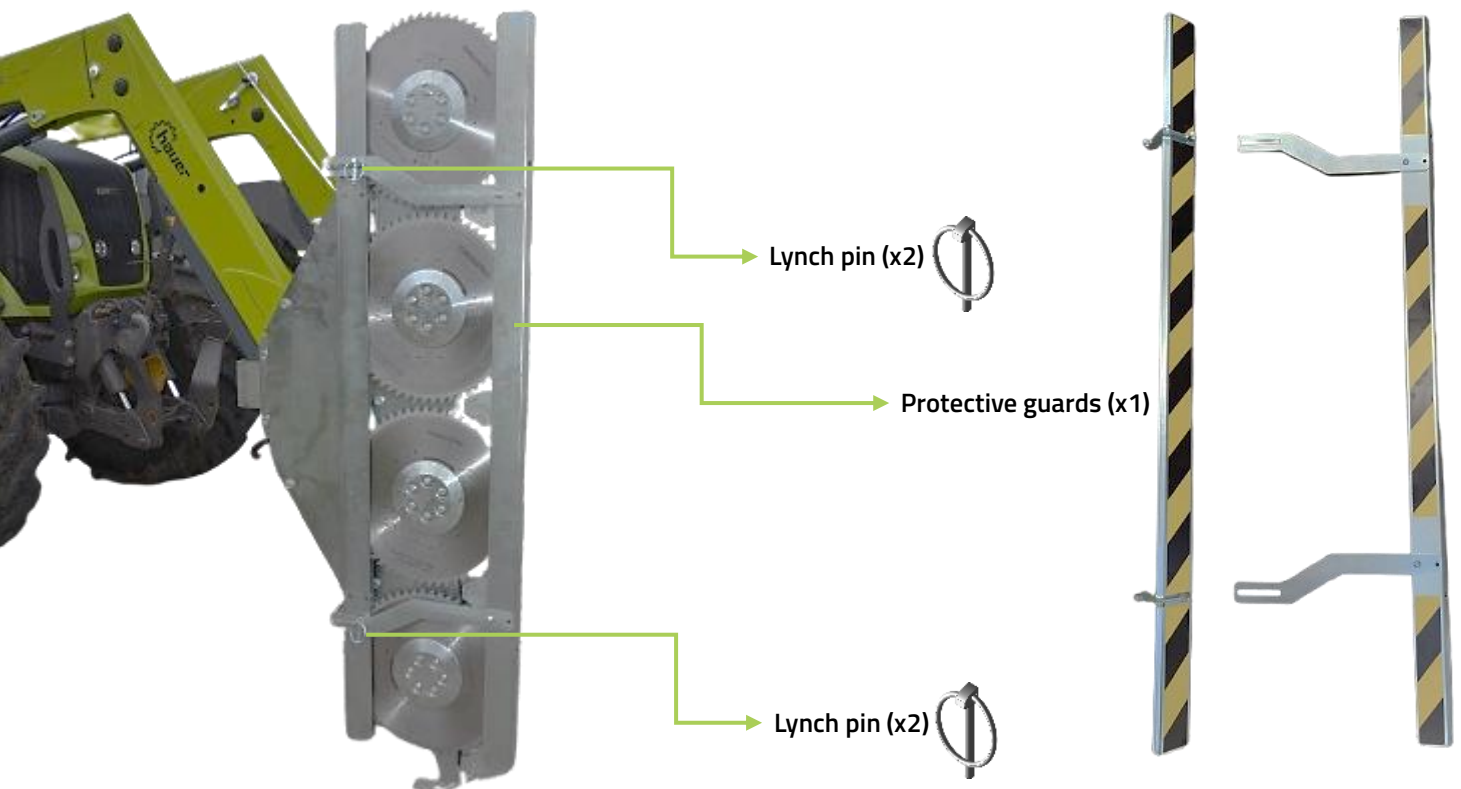

Function of protective guards

#### 4.3.7) Skid shoe

The skid shoe is mounted at the bottom of the mainframe, where it keeps the lowest saw blade from touching the ground.

The skid shoe keeps a safety distance to the ground of approx. 134 mm (5.27")

This prevents any damage to the lower saw blade when working close to the ground in vertical position, during ex. hedge- and/or fence cutting.

The operator avoids having to keep an eye on the safety distance from the ground up to the lower saw blade and instead is able to keep more focus on the cutting result.

#### **CAUTION**

The skid shoe is a safety device to protect the lower blade of the Quadsaw when working close to the ground. Avoid placing the weight of the machinery on the skid shoe.

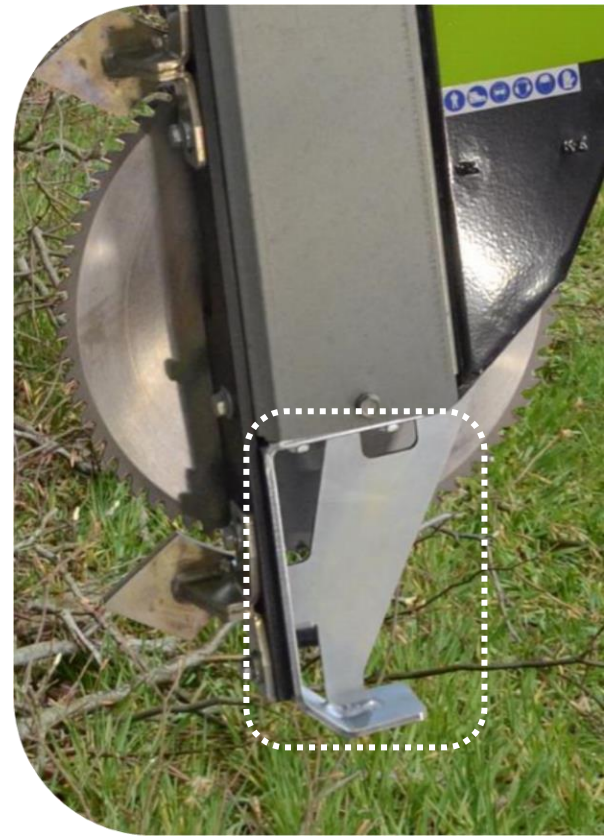

Skid shoe mounted at the lower saw blade



Function of skid shoe

### 4.3.8) Adapter-kits for mounting

GreenTec produces various adapter-kits for use in mounting the attachment tool on different boom mowers, tool carrier and/or vehicles. An adapter-kit is selected when purchasing the machine, and basically consists of the following components:

- Connection/adapter plate
- Bolts/nuts
- Hose kit incl. fittings adapted to the tool carrier \*

Below is a list of the available adapter solutions for mounting the LRS 2002 Quadsaw on selected tool carriers – both boom mowers, multi/tool carriers and possibly vehicles:

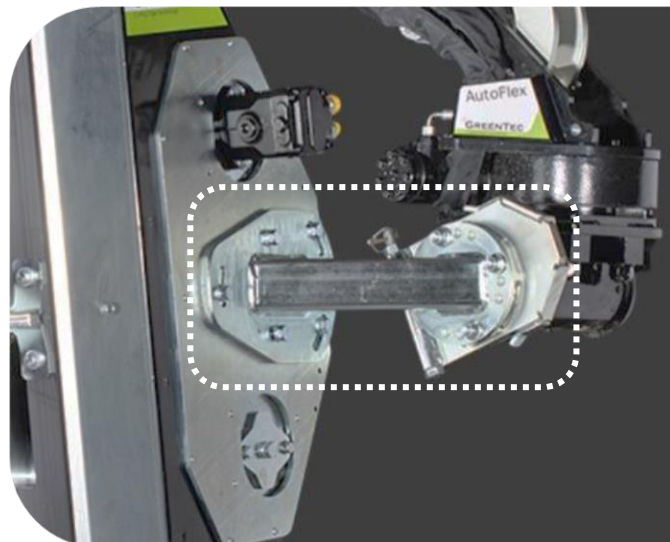

Adapter for mounting: LRS 2002 Quadsaw ↔ Scorpion 5-830 PLUS

## NOTICE

\* An oil flow divider incl. hose kit and fittings are used with adapter-kits for other manufacturers than GreenTec. Further information and data regarding adapter-kits can be found on the product page of the attachment tool and in GreenTec's product database: <https://greentec.eu/support/>

#### ADAPTER-KITS FOR MOUNTING:

<a href="#">OPTE1117</a>	LRS 2002 ↔ Scorpion 5-830 S
<a href="#">OPTE1117.1</a>	LRS 2002 ↔ Scorpion 5-830 S (w/ RotorFlex)
<a href="#">OPTE953.2</a>	LRS 2002 ↔ Scorpion 5-830 S (w/ 90° slew drive)
<a href="#">OPTE1116</a>	LRS 2002 ↔ Scorpion 5-830 PLUS / Spider 5-820 PLUS
<a href="#">OPTE4312</a> / <a href="#">OPTE4315</a>	LRS 2002 ↔ PUMA 3303 / PUMA 3303 Tele Multi Carrier

#### OTHER MANUFACTURERS:

<a href="#">OPTE4080</a>	LRS 2002 ↔ Twiga
<a href="#">OPTE4224</a>	LRS 2002 ↔ Twose
<a href="#">OPTE669</a> / <a href="#">OPTE669.1</a>	LRS 2002 ↔ McConnell (right or left)
<a href="#">OPTE674.2</a> / <a href="#">OPTE674.3</a>	LRS 2002 ↔ Bomford (right or left)
<a href="#">OPTE4292-85</a>	LRS 2002 ↔ Kuhn (85 l/min.)
<a href="#">OPTE4204</a>	LRS 2002 ↔ Mulag
<a href="#">OPTE4282-50</a> / <a href="#">OPTE4282-85</a>	LRS 2002 ↔ Hydrema (50 or 85 l/min.)
<a href="#">OPTE4288-50</a>	LRS 2002 ↔ Dücker DUA (50 l/min.)
<a href="#">OPTE4333-50</a>	LRS 2002 ↔ Dücker UNA (50 l/min.)
<a href="#">OPTE6088-50</a> / <a href="#">OPTE6088-85</a>	LRS 2002 ↔ Excavator (50 or 85 l/min w/ drain)
<a href="#">OPTE4318-50</a> / <a href="#">OPTE4318-50.1</a>	LRS 2002 ↔ Excavator (50 or 85 l/min w/o drain)
<a href="#">OPTE1315</a>	LRS 2002 ↔ Bobcat Skid-Steer (incl. slew drive)
<a href="#">OPTE6082-50</a> / <a href="#">OPTE6082-85</a>	LRS 2002 ↔ Universal (50 or 85 l/min w/ drain)
<a href="#">OPTE4319-50</a>	LRS 2002 ↔ Universal (50 l/min w/o drain)
<a href="#">OPTE953.4</a>	LRS 2002 ↔ Universal (w/ 90° slew drive)

Table 15 – Adapter-kits for mounting on tool carrier

## 4.4) Approved tool carriers and optional equipment (n)

### WARNING











Remember that when assembling with tool carriers and optional equipment other than those produced or approved by GreenTec, it is every operator's own responsibility to ensure that the vehicle and the assembled machine meet the applicable requirements and relevant directives for this!

When mounting on other manufacturers of tool carriers than approved by GreenTec, a new risk assessment of the machinery and equipment must be submitted!

The operational safety of the machine can only be guaranteed if it is used in accordance with its intended use.

If the machine is mounted with an unapproved tool carrier, the basis for risk assessment is void, and thereby the validity and guarantee of the declaration of conformity!

The LRS 2002 Quadsaw is intended for assembly with the following approved tool carriers and possible optional equipment:

APPROVED TOOL CARRIERS:	
Scorpion 5-630 S – Basic Front	 Approved
Scorpion 5-830 S	 Approved
Scorpion 5-830 PLUS	 Approved
Spider 5-820 PLUS	 Approved
PUMA 3303 Multi Carrier	 Approved
PUMA 3303 Tele Multi Carrier	 Approved
APPROVED OPTIONAL EQUIPMENT:	
Hydraulic quick couplings *	 Approved
Mechanical quick-release *	 Approved
Oil flow divider	 Approved
Blade rotor (4 pcs.)	 Approved
OTHER MANUFACTURERS:	
Twiga	 Approved
Twose	 Approved
McConnel	 Approved
Bomford	 Approved
Kuhn	 Approved
Mulag	 Approved
Hydrema	 Approved
Dücker	 Approved
Universal	 Approved

\* Only available as optional equipment with Scorpion- and/or Spider-series.

Table 16 – Approved tool carriers and optional equipment

## 4.5) Optional equipment

### 4.5.1) Hydraulic quick couplings

*(Only available as optional equipment with Scorpion- and/or Spider-series)*

The LRS 2002 Quadsaw is available with quick couplings as optional equipment, for easier connection and disconnection of hydraulic hoses between the attachment tool and the tool carrier.

The quick couplings are of the "Flatface" type and are designed for leak-free connection and disconnection with a safety lock, to prevent accidental disconnection during use and operation.

GreenTec recommends hydraulic hoses to be fitted with Flatface quick couplings when mounting- /unmounting attachment tools, to ensure easy maintenance and cleaning, and that the hoses should not be screwed together using traditional hydraulic fittings.

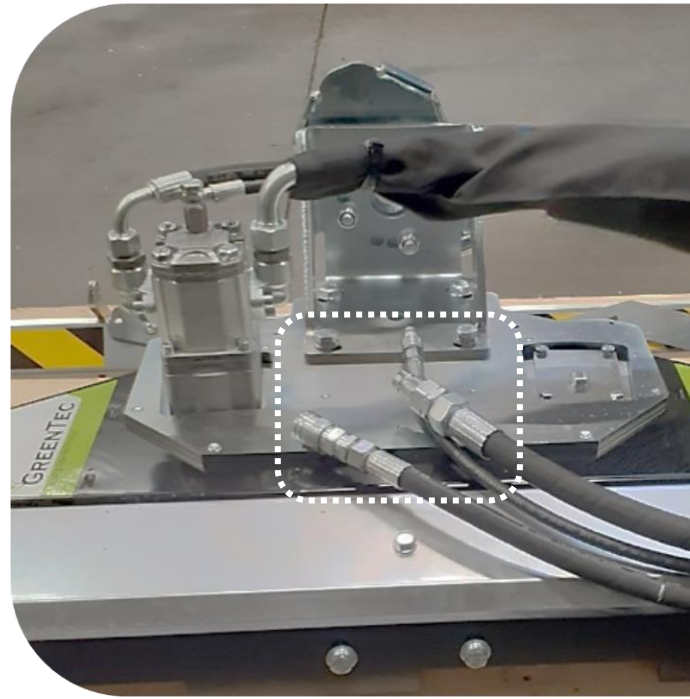

Flat face quick couplings on the hydraulic hoses: LRS 2002 Quadsaw

#### NOTICE

When connecting with hydraulic quick couplings on the attachment tool, outlets for these are also required on the tool carrier.

See section: [Mounting and connection of LRS 2002 Quadsaw on a tool carrier](#) – page 43-46.

#### CAUTION

Before connecting the hydraulic quick couplings, the inserts must be carefully cleaned to avoid excessive wear on the seals.

Use suitable protective components such as plugs and caps when quick couplings are not in use to prevent unnecessary wear or damage.

Shock impacts, such as falling on the ground, may damage your quick coupling. Take precautions to avoid this kind of impact

#### DATA: HYDRAULIC QUICK COUPLINGS

<b>Type:</b>	Q.Safe Flatface
• <b>Quick coupling (female):</b>	P-hose ( <b>Pressure</b> ): 3/4" – S20 (M30 x 2,0)
• <b>Quick coupling (male):</b>	T-hose ( <b>Tank/Return</b> ): 3/4" – L28 (M36 x 2,0)
• <b>Quick coupling (male):</b>	D-hose ( <b>Drain</b> ): 1/2" – L15 (M22 x 1,5)
<b>Force of connection:</b>	120 – 150 N (27 – 33.7 lbf.)
<b>Oil spillage (Connecting and disconnecting):</b>	Leak-free: 0,005 – 0,008 cm <sup>3</sup> (0,0003 – 0.005 in <sup>3</sup> )
<b>Connection under pressure:</b>	Allowed up to 60 bar (870 psi) *
<b>Operating temperature:</b>	-30... +110 °C (-22... +230 °F)
<b>Performance requirements:</b>	ISO 16028:1999

\* Connection under pressure is allowed up to 60 bar (870 psi). Disconnection under pressure is not permitted.

Table 17 – Data sheet: Hydraulic quick couplings



## 4.5.2) Mechanical quick-release

*(Only available as optional equipment with Scorpion- and/or Spider-series)*

The LRS 2002 Quadsaw is available with a mechanical quick-release as additional equipment, for easier connection and disconnection on the tool carrier.

The quick-release system consists of a "male" part that is mounted on the tool carrier, and a "female" part that is mounted on the attachment tool.

The quick-release assembly is secured with a locking bolt, nut and lynch pin.

In combination with hydraulic quick couplings, the quick-release can ensure easy removal and attachment of the attachment tool to the tool carrier, without the use of tools



Mechanical quick-release mounted on LRS 2002 Quadsaw: ("female" part)

### NOTICE

When connecting with quick-release on the LRS 2002 Quadsaw, an adapter for quick-release is also required on the tool carrier itself. Therefore, always check the additional equipment for the tool carrier!

See section: [Mounting and connection of LRS 2002 Quadsaw on a tool carrier](#) – page 43-46.



Example: Quick-release "male" adapter on Scorpion boom mower.



Example: Quick-release "male" adapter on boom mower is paired with the "female" adapter on the attachment tool.

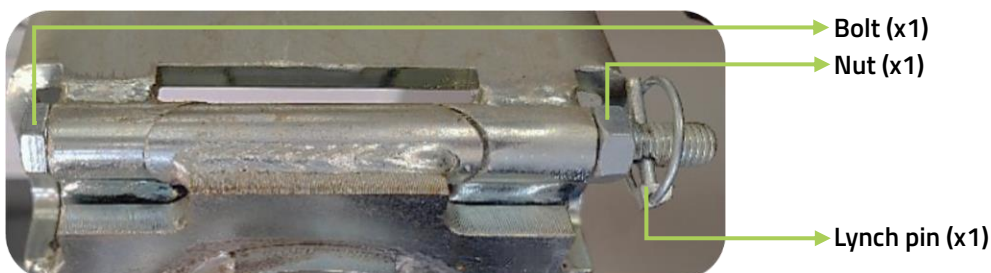

The mechanical quick-release is always locked in place with the included locking bolt, nut and lynch pin.

### 4.5.3) Oil flow divider (universal)

The LRS 2002 Quadsaw can be mounted universally on any vehicle/tool carrier using a universal oil flow divider.

The oil flow divider is preset and ensures that the correct oil flow and pressure is sent from the vehicle/tool carrier's hydraulic outlet to the LRS 2002 Quadsaw.

The oil flow divider has a built-in overpressure and anti-cavitation valve:

- Pressure relief valve for securing and maintaining the preset system pressure for the machinery.
- Anti-cavitation valve to minimize the risk of cavitation damage in connection with pressure fluctuations and/or insufficient inlet pressure.

## NOTICE

These built-in valves between the pressure and return ports open/close to ensure a constant flow of oil to the engine of the attachment tool and/or against overloading of the same.



Oil flow divider (universal) on LRS 2002 Quadsaw

The oil flow divider for the LRS 2002 Quadsaw works by connecting an oil flow of either 50 l/min or 85 l/min from the vehicle's oil outlet including an external pressureless drain connection through its own port: (D)

#### DATA: OIL FLOW DIVIDER (UNIVERSAL)

<b>Connection:</b>	1 x DA: <b>Pressure</b> and <b>return</b> (incl. pressureless <b>drain</b> )
<b>Operating pressure (continuous):</b>	50 l/min @ max. 190 bar (13.21 gpm @ 2756 psi) or 85 l/min @ min. 150 bar (22.45 gpm @ 2176 psi) *
<ul style="list-style-type: none"> <li>• <b>Recommended return pressure (continuous):</b></li> <li>• <b>Max. allowed return pressure (peak):</b></li> <li>• <b>Max. allowed drain pressure (peak):</b></li> </ul>	<ul style="list-style-type: none"> <li>5 bar (72.52 psi) *</li> <li>15 bar (217.56 psi) *</li> <li>0-2 bar (29 psi) *</li> </ul>
<b>Seal type:</b>	NBR
<b>Operating temperature:</b>	-30... +100 °C (-22... +212 °F)

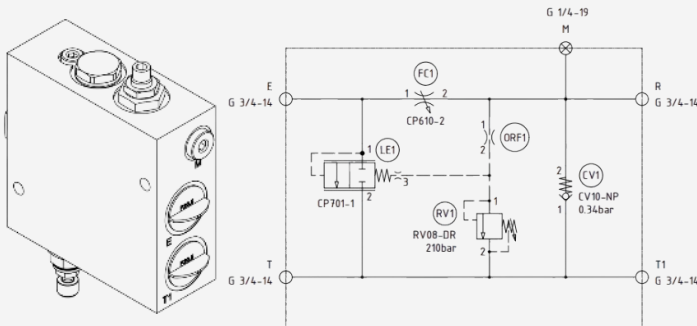

\* Pay particular attention to the performance of the vehicle's oil outlets and connection of the external drain connection. The recommended specifications for especially return and drain pressure on the hydraulic motor must not be exceeded. This can result in serious damage to the hydraulic motor if the regulations for oil flow and pressure are not strictly followed.

Table 18 – Data sheet: Oil flow divider (universal)

#### 4.5.4) Blade rotor (4 pcs.)

The LRS 2002 Quadsaw can also be used with blade rotors instead of regular saw blades.

The blade rotor set consists of 4x steel blade holders with 3x blades per rotor (12 in total), including deflector rail and special tool for changing blades.

The blade rotors are used exclusively for light hedge cutting with a material thickness of 0-2 cm. Anything above that, regular saw blades should always be used. \*

The blade rotors on the LRS 2002 Quadsaw must run at a max. speed of 3200 RPM. The speed of the blade rotors is proportional to the Quadsaw's recommended oil flow of either: 50 l/min or 85 l/min.

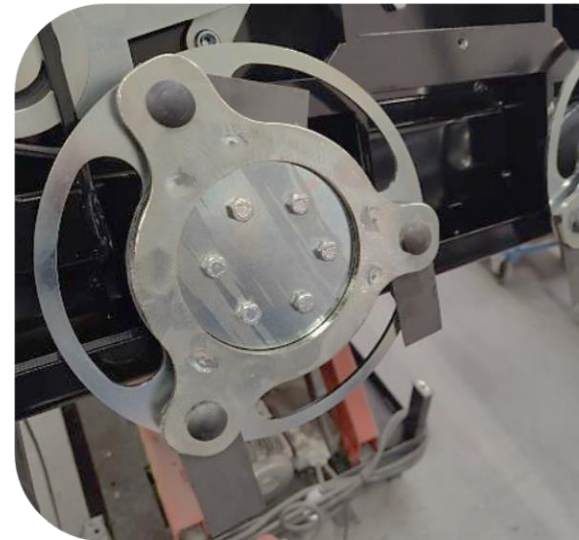

Blades rotor mounted on LRS 2002 Quadsaw

### CAUTION

\* If the RPM and material thickness for the blade rotors are exceeded, the machine's risk assessment and thus the warranty will be void.

### DANGER

When handling the knives-/blades, there is a risk of injury due to the very sharp edges. Recommended safety equipment must always be used!  
See section: [Personal safety equipment](#) – page 6.

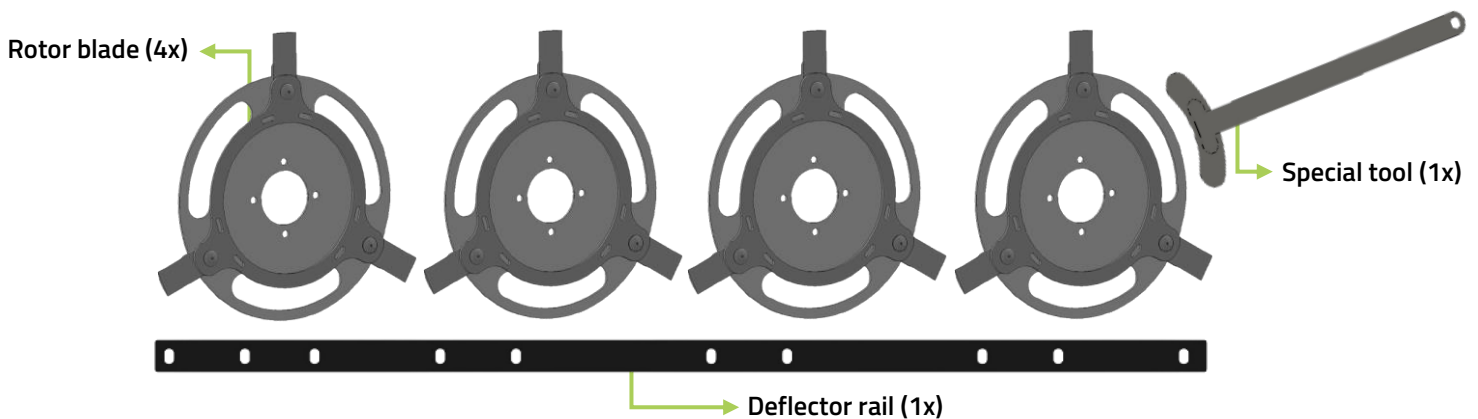

#### DATA: BLADE ROTOR (4 PCS.)

<b>Diameter (outer):</b>	490 mm (19.29")
<b>Cutting width:</b>	5 mm (0.20")
<b>Blade thickness:</b>	5 mm (0.20")
<b>Hole diameter (inner):</b>	80 mm (3.15")
<b>Max. branch thickness:</b>	< 2 cm (0.79") *
<b>Max. speed:</b>	3200 RPM *
<b>Number of blades:</b>	3 per rotor (12 total)
• <b>Length:</b>	40 mm (1.57")
• <b>Width:</b>	40 mm (1.57")
• <b>Material:</b>	Hardened steel.

Table 19 – Data sheet: Blade rotor (4 pcs.)

## 4.6) Specifications

DATA: LRS 2002 QUADSAW	
Width:	2100 mm (6'11")
Working width:	1966 mm (6'6")
Depth:	779 mm (30.66")
Height:	307 mm (11.57")
Weight:	198 kg. (437 lbs.)
Recommended weight (Tool carrier):	From min. 5,000 kg to up over 8,000 kg (From min. 11.023 lbs. to up over 17.637 lbs.) (Always see section: <a href="#">Stability (o)</a> – page 49-50)
Oil motor:	15 cm <sup>3</sup> (0.91 in <sup>3</sup> ) or 28 cm <sup>3</sup> (1.71 in <sup>3</sup> )
Required oil outlets:	1 x DA + external non-pressurized drain connection
Oil requirement:	50 l/min @ max. 190 bar (13.21 gpm @ 2756 psi) or 85 l/min @ min. 150 bar (22.45 gpm @ 2176 psi) *
<ul style="list-style-type: none"> <li>Recommended return pressure (continuous):</li> <li>Max. allowed return pressure (peak):</li> <li>Max. allowed drain pressure (peak):</li> </ul>	<ul style="list-style-type: none"> <li>5 bar (72.52 psi) *</li> <li>15 bar (217.56 psi) *</li> <li>0-2 bar (29 psi) *</li> </ul>
Tightening torque (Belt drive):	New belt: 950 Nm (700.68 lbf·ft) Existing belt: 720 Nm (531.04 lbf·ft)
Tightening torque (Bolts at saw blades):	65 Nm (47.94 lbf·ft)
Max. RPM (Saw blades):	3200 RPM
Max. branch thickness:	0,5 – 16 cm (0.20" – 6.30")
Driving speed:	Max. 5 km/h (3.10 mph)
Working season:	All year.
A-weighted sound level:	Not above >84 dB
Materials:	Hydraulic hoses: Steel reinforced rubber coated Other components: Cast iron and aluminium
Paint:	 Black (Gloss 70-80) = RAL 9005 (Graphite Black)

Table 20 – Data sheet: Machine specifications

### WARNING

\* The oil supply from the tool carrier to the attachment tool used requires a minimum return line pressure to ensure correct working conditions.

It is recommended to always have a return pressure of up to 5 bar (72.5 psi) on the return line at the oil motor. The drain pressure on the oil motor must never exceed the return pressure.

**If the drain line pressure gets higher than the return line pressure while using the machine, the oil motor will be damaged and the warranty for this will be void.**

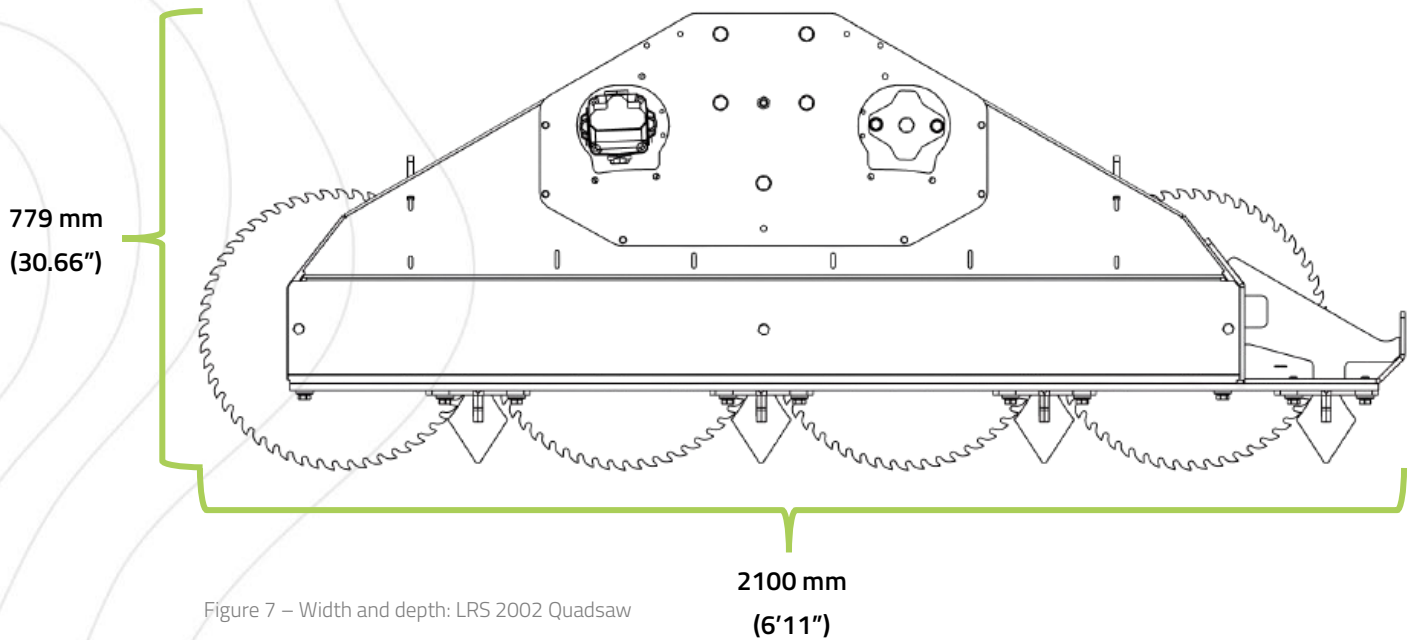

Figure 7 – Width and depth: LRS 2002 Quadsaw

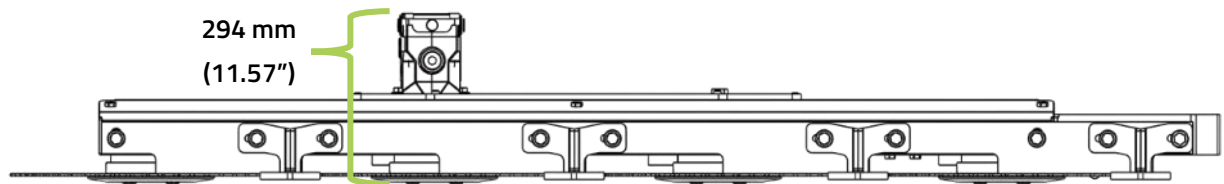

Figure 8 – Height: LRS 2002 Quadsaw

#### 4.7) Noise measurement of airborne noise (u)

Noise measurements were carried out on the machine under normal operating conditions at GreenTec A/S in Denmark, with a Delta OHM sound meter - type HD 8701.

Measurements were carried out 1 meter from the machine's critical noise generators (saw blades) at a height of 1.60 meters (5.25 ft.) from the ground, with starting and using the attachment tool.

Noise level changes in relation to the season and the material being processed; therefore, the noise level may differ to a lesser extent.

The boom mower's noise level will always be lower than the noise level from the attachment tools, as well as the noise from the vehicle in use.

Always follow the precautions intended for the attachment tool and tool carrier and/or vehicle used.

See section: [Safety](#) – page 6-15.

A-WEIGHTED SOUND POWER LEVEL >80 DB	
<b>LRS 2002 Quadsaw</b>	Less than < 85 dB(A)

Table 21 – Measurement of A-weighted sound power level

## 5) Instructions for using the machine (k)

### 5.1) GreenTec.eu – Explore and learn!

On GreenTec's website there is the section: "Explore and learn":

<https://greentec.eu/explore-learn/>

The page contains useful videos and other guidance material on how to use your GreenTec machines as best as possible.

The "Explore and Learn" page can be used as an interactive supplement to the instruction manual for the machine, with e.g., video guides and articles regarding practical use and maintenance of your GreenTec machine.

Whether you are just starting out or a seasoned professional with GreenTec's machines, the "Explore and Learn" page can be useful for anyone who wants to learn more about their attachment tools and/or carriers.

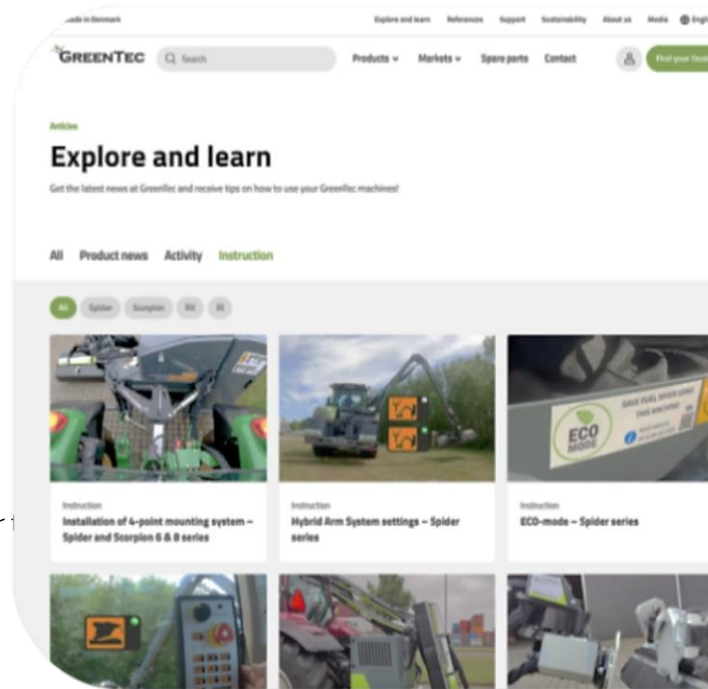

Explore and learn page on GreenTec's website

### 5.2) GreenTec.eu – FAQ

On GreenTec's website there is the section "FAQ":

<https://greentec.eu/support/faq/>

The page contains a collection of the most frequently asked questions regarding technology, use, service, and maintenance of GreenTec machines and equipment.

The "FAQ" page can also be used as a supplement and reference work together with the instruction manual for the GreenTec machine.

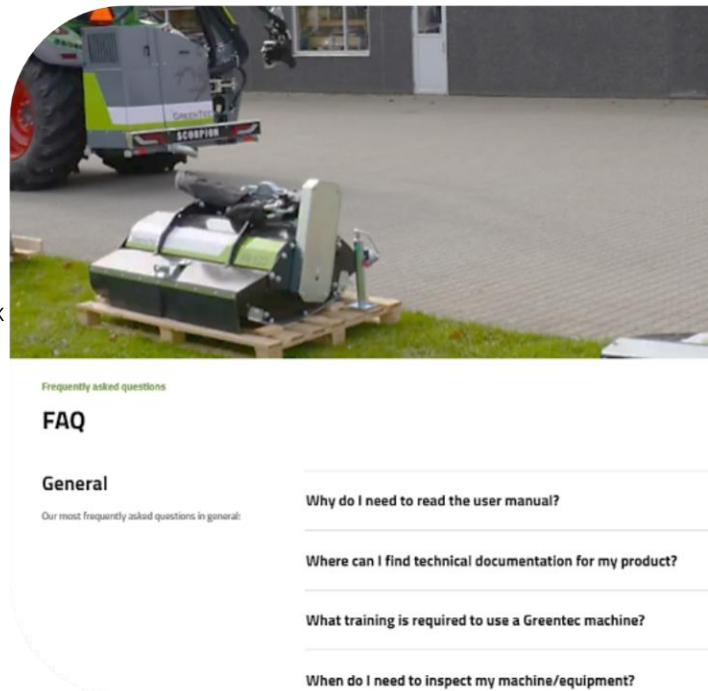

The FAQ page on GreenTec's website

## 5.3) Instructions regarding delivery of the machine

Upon delivery of the GreenTec machine, the following is immediately checked:

1. Check the machine and all included parts for transport damage.  
In case of transport damage, please see section:  
[Transport damage](#) – page 37.

### NOTICE

In the event of deficiencies and/or defects upon delivery, contact the dealer immediately!

2. Check that the following components are included with the LRS 2002 Quadsaw:



Example of delivery of pallet(s) with LRS 2002 Quadsaw

#### CHECKLIST UPON DELIVERY (PER MACHINE):

<b>1x LRS 2002 Quadsaw</b>	Incl. optional equipment. *
<b>4x Saw blades</b>	(incl. 4x mounting plates, 4x dust plates and 16x bolts)
<b>4x Branch guides</b>	(incl. 8x bolts, washers, and spacers)
<b>1x Protective guard for saw blades</b>	(Double-sided protective guard for saw blades)
<b>1x Adapter-kit for mounting</b>	Bracket for mounting on selected tool carriers and/or boom mowers.
<b>1x Hydraulic hose-kit + fittings</b>	3x hoses: <b>Pressure</b> , <b>Return</b> and <b>drain</b> . (pos. hydraulic quick couplings)
<b>1x OPTIKRIK I-belt tension meter</b>	
<b>1x User manual</b>	Digital QR code on the machine. (Physical copy optional upon purchase)
<b>1x Spare parts book</b>	Digital QR code on the machine. (Physical copy optional upon purchase)

\* *Hydraulic quick couplings and mechanical quick-release, optional equipment, are mounted on the machine upon delivery.*

Tabel 22 – Checklist for delivery of machine

### 5.3.1) Transport damage

Upon delivery of the machine, both the machine and accompanying equipment are immediately checked for visible signs of transport damage. If a machine and/or equipment with transport damage is received, it is important that an objection is immediately made to the condition of the shipment, **and that the receipt is signed off with reservations!**

### NOTICE

If it is not noted that the item is damaged or is received with reservations, it is received as undamaged upon delivery, and all compensation claims are waived.

GreenTec is not liable for damages incurred during transport. The carrier, on the other hand, is liable for damages.

Contact your dealer immediately if damaged goods have been received, or if the shipment is rejected because it is damaged.

## 5.4) Instructions for mounting, connection and disconnection (j)

Initial mounting and connection of the machine should always be carried out by the dealer with the necessary knowledge and experience!

When the LRS 2002 Quadsaw is mounted for the first time with an approved tool carrier on the vehicle, in some cases it may be necessary to make further adjustments, especially in relation to stabilization - this should also be carried out at the dealer of the machine.

See section: [Preparing the machine for use](#) – page 48-52.

### DANGER

**The instructions for the machine must be completely understood before any attempts are made to mount, connect, or use the machine. If in doubt, contact the dealer of the machine!**

### WARNING

When mounting and connecting to tool carriers other than those produced or approved by GreenTec, it is every operator's own responsibility to ensure that the vehicle and the assembled machine meet the applicable requirements and relevant directives for this!

When mounting with other makes of tool carriers than specified by GreenTec, a new risk assessment of machines and equipment must be submitted before use!

If an attachment tool is mounted on an unapproved tool carrier, the basis for risk assessment ceases, and thereby the validity and guarantee of the declaration of conformity!

### 5.4.1) Preparation of vehicle and operator

Before attachment tools and other machinery are put into use, it is important that the vehicle incl. operator is properly prepared. This must be done both to achieve maximum safety and to ensure optimal operation during use.

As extra security, safety glass/windows (polycarbonate), safety nets and/or other protective devices can be fitted to the vehicle when it is used together with GreenTec's machines.

In general, the driver of the vehicle should always use safety equipment to reduce the risk of serious injuries such as:

- Eye protection: Net/visor (EN ISO 16321-3:2022) and/or safety glasses (EN ISO 16321-1:2022)
- Hearing protection (EN 352-1:2020), safety helmet (EN 397 + A1:2012), gloves and visible work clothes.

If the vehicle does not have a cab, safety glasses/shields, hearing protection and a helmet must be used:

- Bare skin should be protected with suitable thick clothing against possible plant debris that can hit the driver of the vehicle. See section: [Personal safety equipment](#) – page 6.



## 5.4.2) Preparation of attachment tool

Before the attachment tool is ready for mounting and use, it is also important that its sub-components are assembled correctly in order to achieve both maximum safety and to ensure optimal operation during use.

- 1x [Adapter-kit for mounting](#) on a tool carrier attaches to the LRS 2002 Quadsaw:
  - See section: [Main frame w. central mounting point](#)– page 19, for correct positioning of the adapter-kit.
  - Bolts/nuts for the adapter kit are tightened to the main frame:

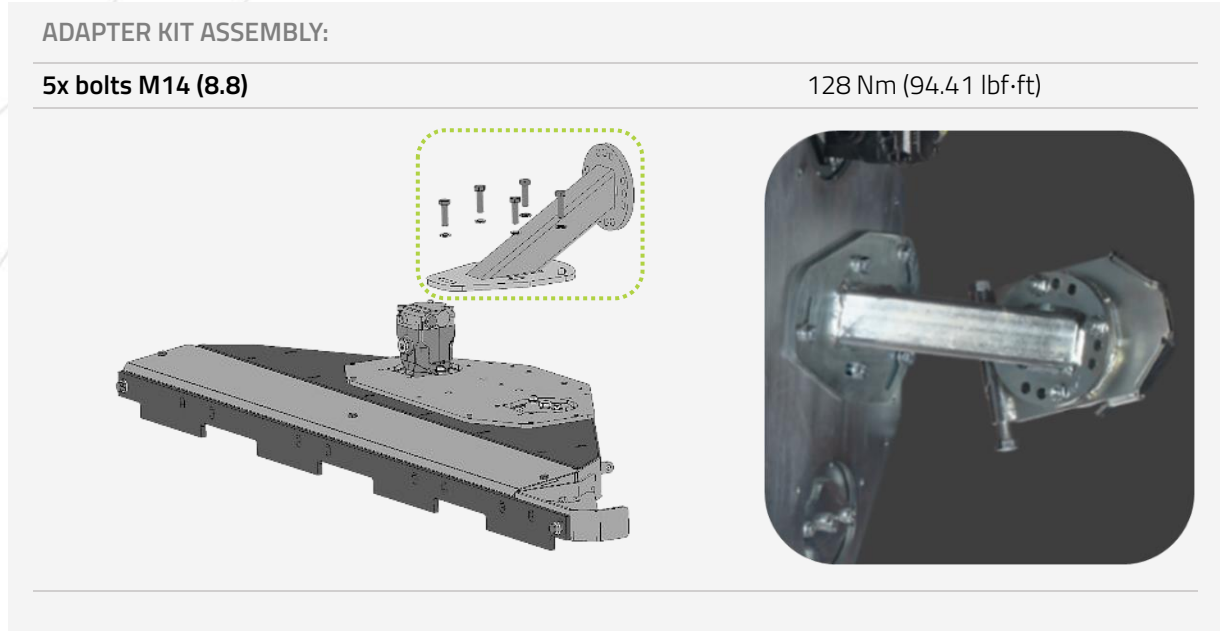

Table 23 – Assembly of the adapter kit

2. 4x [saw blades](#) are mounted and fastened to the LRS 2002 Quadsaw using bolts and mounting plates:

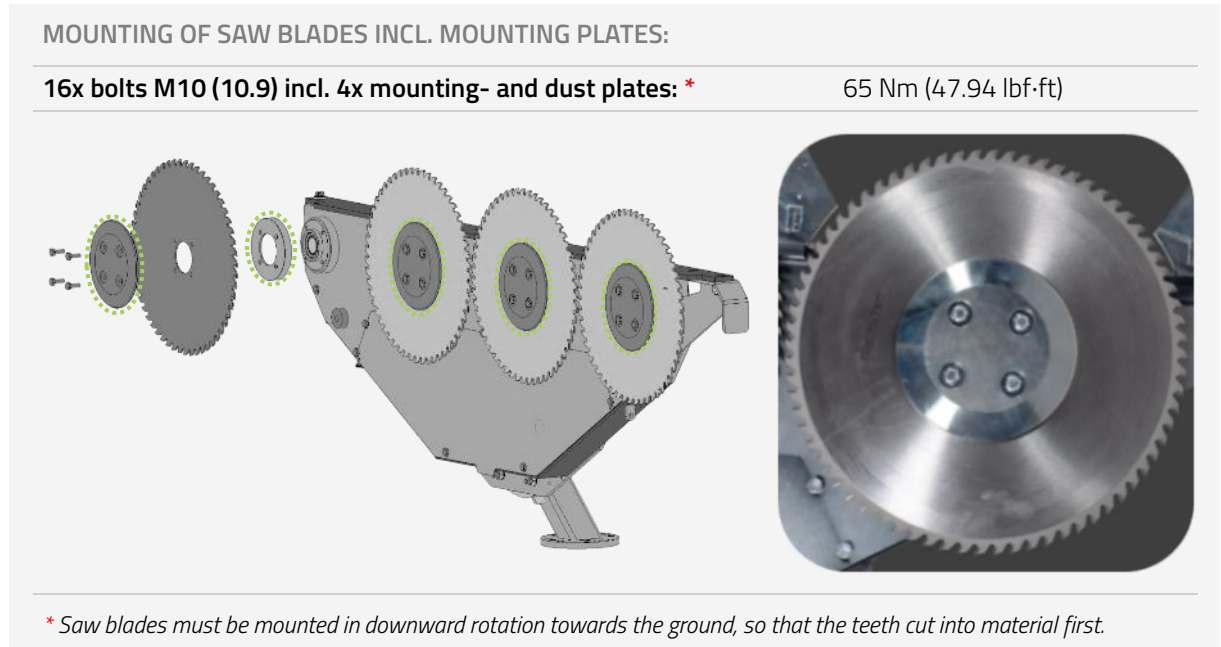

Table 24 – Mounting of saw blades

**⚠ DANGER**

When handling the saw blades, there is a risk of injury due to the very sharp edges. Recommended safety equipment must always be used!  
See section: [Personal safety equipment](#) – page 6.

- The deflector rail is adjusted so that it lies closely along the saw blades and protects against material getting in around the back of the saw blades:

**ADJUSTMENT OF THE DEFLECTOR RAIL FOR SAW BLADES:**

**2x bolts M12 (8.8) incl. washers and spacers: \***

81 Nm (59.74 lbf·ft)

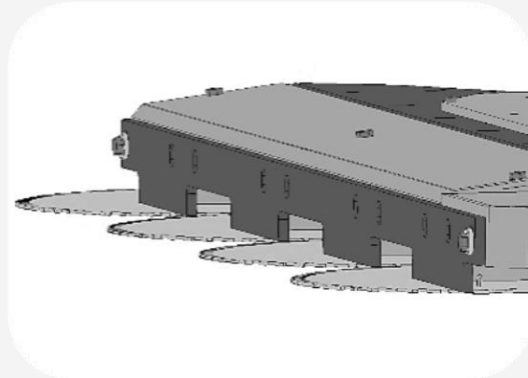
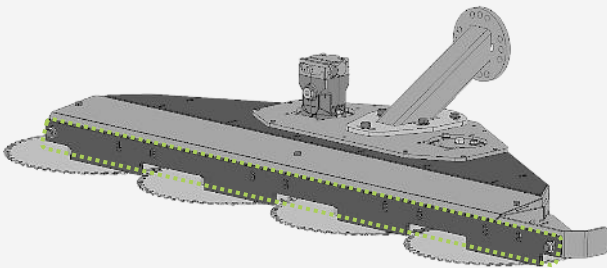

*\* The deflector rail must be adjusted down to the saw blades with a distance of 1-2 mm, without hitting the saw blades.*

Table 25 – Adjustment of deflector rail

- 4x [branch guides](#) for saw blades are mounted and clamped on the LRS 2002 Quadsaw using bolts, spacers, and washers:

**INSTALLATION OF BRANCH GUIDES AT SAW BLADES:**

**8x bolts M12 (8.8) incl. washers and spacers: \***

81 Nm (59.74 lbf·ft)

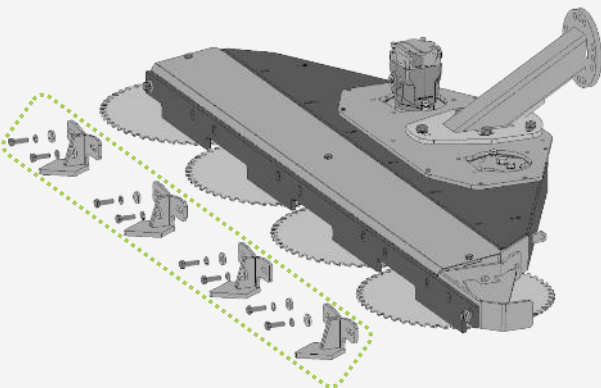

*\* The branch guides must be adjusted as close as possible to the saw blades, without hitting the saw blades.*

Table 26 – Installation of branch guides at saw blades

- The [protective guards](#) for the saw blades is mounted using lynch pins in the holes on the lower protective guard and main frame:

#### INSTALLATION OF PROTECTIVE GUARDS FOR SAW BLADES:

##### 4x lynch pins in holes on protective guard and main frame:

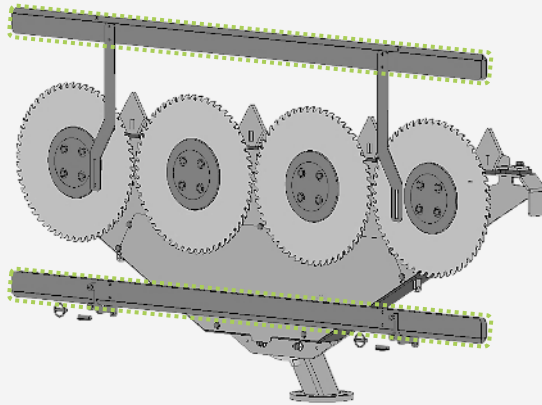

Table 27 – Installation of protective guards for saw blades

- Hose kit + fittings are fastened to the outlets on the LRS 2002 Quadsaw's hydraulic motor:

- See section: [Oil motor](#) – page 20, for correct connection of hoses to the motor.
- Hose fittings are tightened at the engine outlet:

#### TIGHTENING OF FITTINGS FOR HYDRAULIC HOSES:

<b>P-Hose (Pressure):</b> 3/4" – L15 (M22 x 1,5)	70 Nm (51.63 lbf·ft)
<b>T-Hose (Tank/Return):</b> 3/4" – L22 (M30 x 2,0)	120 Nm (88.50 lbf·ft)
<b>D-Hose (Drain):</b> 3/8" – L12 (M18 x 1,5)	50.0 Nm (36.88 lbf·ft)

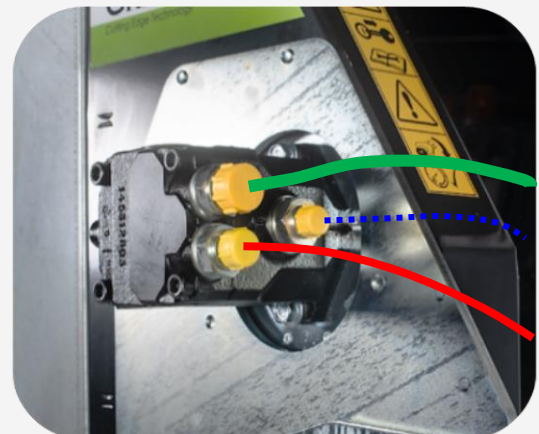
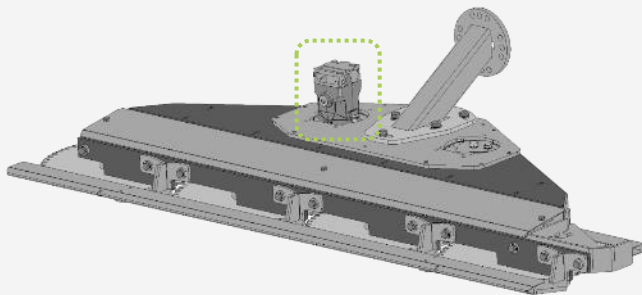

\* Hydraulic quick couplings (optional equipment) are mounted either on the hoses or on the hydraulic motor, depending on the configuration between the attachment tools and the tool carrier.

Table 28 – Tightening of fittings for hydraulic hoses

### 5.4.3) Mounting and connection of the machine (i)

The mounting and connection procedure may differ from vehicle to vehicle! For this, always use the instructions of the vehicle used in combination with both the tool carrier and the instructions of the attachment tool.

Assembly on different types of vehicles with different tool carriers is broadly the same procedure, but always investigate the procedure for the combination of machines used on your own.

Common to all GreenTec attachment tools is that these are mounted either by bolting on to the standard attachment, or via [mechanical quick-release](#).

Depending on which adapter/mounting bracket is used, these must be mounted depending on the tool carrier, and bolts/nuts must be tightened according to [Table 37](#) – page 67.

#### DANGER

**Never use the tool carrier with a mounted attachment tool on an unstable or unsuitable vehicle!**

**There must be no people or animals near the vehicle due to the risk of collision and/or overturning!**

**Never allow other people to stand on or near the lift system during work due to the risk of crushing!**

**The vehicle and the machine must be operated from the driver's seat of the vehicle!**

#### WARNING

Mounting and connection of the machine must only be carried out by professionals who have knowledge and understanding of hydraulic systems, in order to avoid pollution of the environment, leaks and contamination of the closed hydraulic system!

#### WARNING

Installation of attachment tools and tool carriers on a vehicle must take place on a level and safe surface!

Great care must always be taken when attachment tools with a connected tool carrier are mounted and connected to the vehicle!

### 5.4.3.1) Mounting and connection of LRS 2002 Quadsaw on a tool carrier:

## **NOTICE**

The mounting instructions show and explain how the LRS 2002 Quadsaw is mounted on an approved tool carrier using mechanical quick-release and hydraulic quick couplings.

The installation instructions assume that the approved tool carrier on the vehicle has already been installed and connected correctly according to its instruction material.

#### MOUNTING AND CONNECTION: LRS 2002 QUADSAW

1. **Using a pallet, place the LRS 2002 Quadsaw on a firm and stable surface, with good maneuvering space around the machine:**

(PICTURE)

2. **Drive the vehicle with mounted tool carrier around the side of the attachment tool, so that the operator have a good view of the machine from the driver's cab and where the adapter bracket on the tool carrier can reach the adapter bracket on the attachment tool without being in its outer position:**

(PICTURE)

3. **The adapter bracket of the tool carrier is slowly moved to the adapter bracket of the attachment tool and the 2 machines are carefully hooked together:**

(PICTURE)

Table 29 – Mounting and connection of LRS 2002 Quadsaw on tool carrier (1/3)

4. The adapter bracket is secured using a bolt, nut, and lynch pin. The bolt does not require any tightening but must be tightened enough so that it can be secured using a locking lynch pin. The attachment tool can now be safely lifted from the ground using the tool carrier's lift/arm system.

(PICTURE)

**⚠ WARNING**

The operator must always ensure that the attachment tool is fully hooked when it is lifted from the ground and before leaving the cab!

5. 3x hydraulic hoses from the attachment tool are connected to the double-acting oil outlet on the tool carrier

(PICTURE)

**DK : TRYK  
UK: PRESSURE  
D: DRÜCK**

The attachment tool must be supplied with either 50 l/min @ max. 190 bar (13.21 gpm @ 2756 psi) or 85 l/min @ min. 150 bar (22.45 gpm @ 2176 psi) \*

**DK : RETUR  
UK: RETURN  
D: RÜCKLAUF**

The return back pressure on the attachment tool must be between 5-15 bar (72.52-217.56 psi). \*

**DK : DRÆN  
UK: DRAIN  
D: LECK**

When drain connection on the attachment tool, it must never exceed a back pressure of max. 2 bar (29 psi) and must never be connected to the return connection!

\* The oil motor on the attachment tool needs a minimum return line pressure to ensure correct working conditions.

*GreenTec's machines run with an open hydraulic circuit that includes a pumping station, engine, and oil tank. One of the advantages of an open circuit is greater heat reduction compared to a closed circuit.*

*Hydraulic oil is pumped from the tank, through the components and back to the tank. Here the oil loses heat before it is run through the system again.*

Table 30 – Mounting and connection of LRS 2002 Quadsaw on tool carrier (2/3)



**⚠ WARNING**

The drain pressure must never exceed the return pressure on the machine! A higher back pressure than permitted on the drain connection results in serious damage to the oil motor and the warranty for this is void! The drain connection must therefore **always** be routed by itself as a pressureless tank connection and must never be connected to the return connection!

**⚠ WARNING**

Always remember to turn the locks on the hydraulic quick couplings to avoid accidental disconnection when a branch sweeps over the quick couplings! If one of the hydraulic connections is broken loose during use, the oil motor will be damaged and the warranty for this will be void!

**⚠ CAUTION**

Before connecting the hydraulic quick couplings, the inserts must be carefully cleaned to avoid contamination and wear on the seals. Use suitable protective components such as plugs and caps when quick couplings are not in use to prevent unnecessary wear or damage. Impacts, such as falling to the ground, can damage a hydraulic quick coupling. Take precautions to avoid this type of impact.

**⚠ CAUTION**

Hydraulic hoses must always be routed and installed so that they can move freely with the movements of the attachment tool and the tool carrier, without getting pinched, detached or otherwise damaging the machine or other equipment!

6. As soon as the attachment tool and tool carrier are fully connected, prepare the machinery for transport from the section on:

(PICTURE)

[Transport of attachment tools on a vehicle \(p\)](#) – page 54.

---

7. Drive the machinery out to a large area with firm ground, plenty of space and no people/animals in a minimum radius 20 meters.

Start the tool carrier here, without starting the attachment tool, and follow all the procedures for initial start-up, use and stability in the following section: [Preparing the machine for use](#) – page 48-52.

(PICTURE)

---

Table 31 – Mounting and connection of LRS 2002 Quadsaw on tool carrier (3/3)



### 5.4.3.2) Un-mounting and disconnection of LRS 2002 Quadsaw on a tool carrier:

Un-mounting and disconnection of the attachment tool is done in the reverse order, cf. section on [Mounting and connection of LRS 2002 Quadsaw on tool carrier](#) – page 43-46.

#### **WARNING**

Un-mounting and disconnection of the attachment tool must take place on a flat and safe surface.

Great care must always be taken when un-mounting the attachment tool and disconnecting the tool carrier.

#### **CAUTION**

The attachment tool must always be un-mounted before the tool carrier is disconnected and removed from the vehicle!

When un-mounting and/or replacing attachment tools, always check the hydraulic system for residual pressure!

A possible residual pressure in the system is reduced to zero (**0 bar / 0 psi**) before disconnecting the hydraulic hoses!

When un-mounting the tool carrier, follow the instruction material for the tool carrier used!

#### **NOTICE**

The attachment tool can be advantageously placed on a transport pallet when un-mounting and disconnecting. The attachment tool can thus be moved around more easily.

## 5.5) Preparing the machine for use

After complete mounting and connection of the attachment tool to the tool carrier/vehicle, the following procedures in this section are carried out before putting the machine into use:

### 5.5.1) Procedures before start-up and use

The operator of the machine must always have read and understood the instruction material, for both vehicle, tool carrier and the attachment tool in use!

Before start-up and use, be sure to have reviewed all points, instructions and procedures in the following sections of this instruction manual:

- [Safety](#) – page 6-15.
- [Instructions for using the machine \(k\)](#) – page 36-37.
- [Instructions for mounting, connection and disconnection \(j\)](#) – page 38-47.
- [Stability \(o\)](#) – page 49-50.
- [Daily and routine inspections \(e\)](#) - page 65-66.

### 5.5.2) Training of machine operators before use

The GreenTec attachment tool may only be used mounted with tool carriers approved by GreenTec, and on an approved vehicle as a single unit.

The operator of a vehicle with a tool carrier and attachment tool mounted must therefore both review and understand the instruction material for the attachment tool as well as the instruction material for the tool carrier and the vehicle used, before putting the machine into use.

The operator must be competent and fully capable of working with this machine in a safe and efficient manner before using it in a public place.

#### **DANGER**

**The instructions must be completely understood before attempting to mount, connect or use the machine.**

**If there is any doubt, contact the dealer or GreenTec's After-sales service!**

**GreenTec offers paid commissioning at the customer's place when purchasing a machine!**

### 5.5.3) Stability (o)

When driving with the attachment tool, the operator must always be aware that the machine's centre of gravity shifts during work:

#### **⚠ DANGER**

**After mounting and connection it must always be ensured that the complete vehicle is stable enough to be able to carry the tool carrier with the attachment tool attached.**

**Especially that the vehicle is stable enough sideways, also when the attachment tool is working at a greater height and hangs on the side of the vehicle, as well as when driving on an uneven surface and/or in a bend!**

#### **NOTICE**

Depending on the weight and stability of the vehicle used with the tool carrier and attachment tool, it may be necessary to use front-side or rear weights to maintain stable rear axle pressure on the opposite wheels from which the attachment tool is mounted.

The suggestions below are only indicative in terms of stability and are not a direct instruction to strengthen the stability of the specific vehicle.

It is recommended that the dealer of the vehicle be contacted, for specific advice on increased stability, and/or for advice and guidance on tire pressure etc. for the vehicle on which you want to mount the tool carrier and attachment tool.

#### 5.5.3.1) Checking the stability:

#### **⚠ CAUTION**

Carefully examine the stability of the vehicle/tool carrier with the attachment tool mounted!

Slowly operate the attachment tool all the way to the outer position using the tool carrier's arm system. Leave the attachment tool at a low height: Max. ½ meter (1.5 ft.) above the ground.

(The attachment tool **is not to be started** during this check!)

#### **Perform the following procedures:**

1. Ensure that the machine is in working position with the tool carrier arm system fully extended to the outer position. Let the attachment tool be max. ½ meter (1.5 ft.) above the ground.
2. Carefully move the vehicle with the tool carrier mounted, as well as move the working angle of the attachment tool around the entire range of movement: both horizontally and vertically.
  - a. Is the vehicle stable on all 4 wheels?
  - b. Are the lift arms stable?
3. Is the vehicle stable when turning and driving around - also on uneven terrain?

4. Assessment is made in each individual situation, and it is the full responsibility of the operator and operators to ensure that the vehicle does not overturn or tip over. If the vehicle and tool carrier are stable, the attachment tool can be moved up step-by-step.
5. If the operator judges that the vehicle and tool carrier are not stable, the vehicle must be stabilized. (Follow the instruction manual for the vehicle in use!)

#### **5.5.3.2) Stability can be increased by:**

- Mounting counterweights on the vehicle and/or tool carrier.
- Top up water in the vehicle's tyres. (Check with the tire manufacturer, and remember frost protection at temperatures close to or below freezing)
- Track width of the vehicle; the longer the wheels are out, the greater the stability. (To be examined at the vehicle dealer)
- Stabilizer on the front axle, especially on the attachment tool's side. (To be examined at the vehicle dealer)

### **⚠ DANGER**

**It is especially important that the operator has an understanding of the stability and that you must always drive according to the conditions!**

**Never use the tool carrier with attachment tools on an unstable or unsuitable vehicle.**

#### **5.5.3.3) Factors influencing stability:**

- The centre of gravity of the machine combination and the height at which work is being done in combination with the weight hanging out on the side of the vehicle.
- Weight, counterweight, track width and vehicle wheelbase.
- Acceleration, braking, turning and the relative position of the attachment tool during these manoeuvres.
- The nature of the terrain: are you driving uphill, downhill or on a slope? What is the type of surface: soft, hard, or uneven?
- Pay special attention to the fact that articulated loaders shift the weight balance significantly more to the side, the sharper the turn.

## 5.5.4) Initial start-up and commissioning

The initial start-up of the machine for use, like the initial mounting and connection of the machine, should always be carried out by the dealer with the necessary knowledge and experience.

When the attachment tool is to be used for the first time with an approved tool carrier on the vehicle, it is recommended to always go through the steps below to ensure an optimal and safe first start-up of your machine:

PROCEDURES FOR INITIAL START-UP AND COMMISSIONING:	
<b>1. Check the stability of the machinery:</b>	Before the first start-up and commissioning, it must always be ensured that the complete vehicle is stable enough to be able to carry the tool carrier with the attachment tool attached. (See section: <a href="#">Checking the stability</a> – page 49-50)
<b>2. Check the bolts of the machinery:</b>	Make sure that all bolt assemblies on the machinery are correctly tightened, especially bolts for the saw blades and bolts at the adapter bracket for between the attachment tool and the tool carrier. (See section: <a href="#">Tightening of bolts</a> – page 67)
<b>3. Start the machinery for the first time by activating the oil supply from the tool carrier:</b>	Let the machine run for approx. 5 minutes at idle with low revs, to warm up the hydraulic oil before use.
<b>4. Inspect the hydraulic system for leaks:</b>	Hydraulic hoses and fittings are inspected for possible leaks and are tightened. (See section: <a href="#">Tightening of hydraulic hoses- and fittings</a> – page 68)
<b>5. Check and prove the pressure specifications of the machinery:</b>	Max. allowed pressure: 50 l/min @ max. 190 bar (13.21 gpm @ 2756 psi) or 85 l/min @ min. 150 bar (22.45 gpm @ 2176 psi) Max. return backpressure: 5-15 bar (72.52 – 217.56 psi) * Max. allowed drain backpressure: 0-2 bar (0 – 29 psi) * (See section: <a href="#">Checking pressure- and flow specifications</a> – page 77)

Table 32 – Procedures for initial start-up and commissioning



**\* Always check and prove the pressure specifications by measuring at each start-up!**

**The driver of the vehicle must know how the oil should be handled (Always see the safety data sheet for the hydraulic oil used!)**

**Oil splashes under high pressure from damaged fittings or hydraulic hoses can penetrate the skin and cause serious injuries!**



The drain pressure must never exceed the return pressure on the machine!  
A higher back pressure than permitted on the drain connection results in serious damage to the oil motor and the warranty for this is void!

The drain connection must always be routed by itself as a pressureless tank connection and must never be connected to the return connection!



**⚠ CAUTION**

Always start up carefully when using for the first time and only drive in a private area until familiarity is achieved in using the machinery with the attachment tool mounted!

**NOTICE**

GreenTec recommends running the machinery at slow idle before use to warm up the hydraulic oil. It helps to protect the hydraulic components and significantly extend the life of both the motor and the pump!

## 5.6) Operation of the machine (e)

This section describes the handling of the machine, the operator's workplace when the machine is used, as well as operation and use of the machine.

### 5.6.1) Operator's workplace (f)

The attachment tool must always be mounted on an approved tool carrier using a vehicle and therefore the attachment tool is handled when operating from the vehicle.

#### **WARNING**

The operator must take breaks if this is deemed necessary and be aware of the strain from the working position.

#### **CAUTION**

Very much depending on how the tool carrier/attachment tool is positioned in relation to the operator, there may be stressful working positions.

It is important that the operator can follow and control the work of the equipment, while at the same time being aware of the course of the road, traffic conditions etc.

It is many things at once, and often with a twist on the back and/or neck. In the long term, this can put a strain on the body's musculoskeletal system, and it is therefore recommended to take appropriate breaks as needed during use.

#### **NOTICE**

Know and understand the operation of both the vehicle and the tool carrier, in order to control the attachment tool safely. The assembled machinery must be operated so that it is controlled in the most appropriate way, according to their instruction material.

The operator's workplace is always the vehicle's cab, where the tool carrier and attachment tool's control panels etc. are placed.

## 5.6.2) Transport of attachment tools on a vehicle (p)

When transporting a tool carrier with any attachment tool, the most appropriate transport position depends both on the combination of tool carrier and attachment tool, but also on the vehicle used together with the tool carrier and attachment tool.

Since there are many combinations of tool carriers with different attachment tools mounted, as well as options for mounting additional equipment, it is important to find the best transport position for exactly your combination of machines.

The installation of various additional equipment can provide both opportunities and limitations for the location of the work tool during transport, and the vehicle design can also change the possibilities for the transport position of the work tool.

- Common to all transport positions for GreenTec's attachment tools mounted on approved tool carriers, is that the construction of the arm system ensures that the attachment tool always point towards the vehicle, without being a danger or a nuisance to either the driver, pedestrians or other road users.
- Common to all transport positions for vehicles is that the positioning must not block either visibility or lights/blinders; both on the vehicle as well as on any light beam on tool carrier.

### **⚠ DANGER**

**ALWAYS drive with ALL safety guards on, e.g., saw blades, when transporting all types of attachment tools.**

**Likewise, always try to turn attachment tools towards/along the vehicle and away from other traffic and pedestrians.**

### **⚠ WARNING**

When driving on public roads, it is always the operator's responsibility to always comply with applicable traffic laws and regulations! GreenTec cannot be held responsible for any violations of traffic laws and regulations while driving with tools carriers and/or attachment tools!

The attachment tool must not cover either the vehicle's or tool carrier's lights and/or the operator's view! Otherwise, additional lighting should be installed!



Example of transport position: LRS 2002 Quadsaw mounted together with Scorpion 3-430 boom mower. Lights free on tool carrier and vehicle



LRS 2002 Quadsaw in transport position with safety devices fitted (Protective guards for saw blades)



### 5.6.3) Start of attachment tool

The attachment tool can be started as soon as it is mounted correctly, and the tool carrier is in the working position. See sections: [Instructions for mounting, connection and disconnection \(j\)](#) – page 38-47 + [Preparing the machine for use](#) – page 48-52 + [Operation of the machine \(e\)](#) – page 53-62.

#### DANGER

**Always make sure to check the immediate area around the machine and the vehicle before starting and during operation of the work the machine must perform. The size of the area depends on which attachment tool is used.**

**Always handle heavy machinery with care and caution, and always follow the regulations described in the attachment tool, tool carrier and vehicle instruction manual!**

The attachment tool must always be started at the lowest oil supply / RPMs from the tool carrier:

1. The tool carrier is started by applying low oil flow / PTO revolutions from the vehicle's hydraulic system.  
**(Always refer to and follow the instructions of the vehicle / tool carrier used as these will vary!)**

#### NOTICE

For PTO-driven machines: Always start with the attachment tool hovering above the ground, and preferably in a place where there is room for extra movement, to find the correct PTO RPM.

2. The attachment tool is started using the tool carrier's controls, and the saw blades rotate at low revolutions. A slow start is advised until the blades reach their recommended speed.
3. Let the attachment tool run without load for 5-10 min., until the hydraulic oil in the system is heated up.
4. When the hydraulic oil is at operating temperature, the optimum oil flow of minimum 50 l/min @ max. 190 bar (13.21 gpm @ 2756 psi) or 85 l/min @ min. 150 bar (22.45 gpm @ 2176 psi) for the machine is found as follows:
  - a. With the attachment tool running at low oil flow/rpm from the vehicle / tool carrier's hydraulic system, the oil flow from the hydraulic system is slowly increased.
  - b. Stop increasing the oil flow when the optimum oil flow of minimum 50 l/min @ max. 190 bar (13.21 gpm @ 2756 psi) or 85 l/min @ min. 150 bar (22.45 gpm @ 2176 psi) is achieved, or until the tool carrier incl. the movements of the attachment tool are smooth and continuous.  
(Here, several movements may be made at the same time - move the control panel/joystick!)
5. The correct oil flow from the vehicle ensures the most comfortable use of both the tool carrier and the functions of the attachment tool and minimizes fuel consumption and heat in the hydraulic system.

#### WARNING

The flow specifications (l/min @ bar or gpm @ psi) must always be kept within the regulations for tool carrier and attachment tool and must never be exceeded. See sections: [Specifications](#) – page 34 + [Mounting and connection of the machine \(i\)](#) – page 42-46.

#### 5.6.4) Stop of attachment tool

The attachment tool must always be stopped at the lowest oil supply / RPMs from the tool carrier:

1. The attachment tool is stopped by first running it down to a low oil flow / low RPM on the vehicle!  
(Always refer to and follow the vehicle instructions used as these will vary from vehicle to vehicle!)
2. The attachment tool is stopped completely using the tool carrier's controls, and the rotation of the saw blades stops.
3. Allow the attachment tool to run without load until it stops, then turn off the vehicle's hydraulic system.

### **⚠ DANGER**

**Many attachment tools have heavy blades or rotors. Therefore, these will often rotate for up to 30 seconds after the hydraulic supply is cut off!**

**Never go near attachment tools without making sure that the rotating parts have come to a complete stop!**

## 5.6.5) Setting and adjusting the machine (r)

Setting and adjusting the machine always depends on the vehicle and/or tool carrier that is mounted together with the attachment tool. In general, both vehicle incl. tool carrier, is handled and adjusted so that the attachment tool that is mounted does the best possible job, in the safest way.

Common to all attachment tools is that they must be mounted on a tool carrier, connected, and then moved from the transport position into the work position.

Handling of specific tool carriers is described in their instruction manuals! Check the instruction material for the tool carrier used!

### **CAUTION**

Pay special attention to any collision protection function / "Break-back" function when the tool carrier is set and adjusted to working position with the attachment tool attached! See section: [Driving instructions](#) – page 59-61.

The settings and adjustment options for the LRS 2002 Quadsaw are described below:

### 5.6.5.1) Adjusting the branch guides:

The saw blades rotate against the surface of the earth and saw/cut in a downward direction.

In order to achieve the best possible cut per saw blade, each individual branch guide should always be adjusted closest to the saw blade that is placed above each of the 4 x branch guides on the machine.

When a branch guide is adjusted closely to the saw blade, it is ensured that the material is guided directly towards the cutting edge of the saw blade, where even the smallest branches are caught and pruned.

The adjustment of branch guides should be inspected continuously and must generally take place in connection with the preparation of the attachment tool, before start-up and commissioning.

See section: [Preparation of attachment tool](#) – page 39-41.



Branch guide adjusted on LRS 2002 Quadsaw

### **NOTICE**

The adjustment of branch guides should be checked continuously and must generally take place in connection with the preparation of the attachment tool before start-up and commissioning.

### 5.6.5.2) Setting the cutting angle:

On most tool carriers (PUMA, Scorpion etc.) it is possible to set the angle of an attachment tool using the tool carrier's arm system and/or mounting bracket.

The procedure for setting the cutting angle differs from tool carrier to tool carrier, and also from attachment tool to attachment tool.

Depending on the configuration with the tool carrier, the operator has the opportunity to adjust and angle the Quad-saw both vertically and horizontally so that the best possible cutting result can be achieved, in relation to the material that the machine must work with.

It is recommended to set the cutting angle of the LRS 2002 Quadsaw in a position that ensures that the saw blades meet the branches in a vertical/upright position.

Use smaller movements here. Larger corrections to the cutting angle are best carried out while the machinery is stationary.



Setting the cutting angle on the LRS 2002 Quadsaw

## NOTICE

The LRS 2002 Quadsaw is recommended to be angled vertically with an offset of approximately 250 mm (9.84") between the upper and lower saw blades. This ensures that the Quadsaw meets the material in the best possible way and that the optimal cutting result is achieved. See section: [Driving instructions](#) – page 59-61.



Displacement / angulation of the LRS 2002 Quadsaw in the vertical direction

## 5.6.6) Driving instructions

The machinery must always be operated and used in the most appropriate way, so that you achieve the best possible result and the greatest safety during use.

### **⚠ DANGER**

**The machinery must at all times be used within the limitations of the machine's safety instructions, intended use and area of application, so that it is always used for its intended purpose.**

See sections: [Safety – page 6-15](#) + [Intended use of the machine \(g\) + Application and restrictions of the machine \(h\) – page 18](#).

### **⚠ DANGER**

**Under no circumstances should people or animals stay within the working area of the machinery during use!**

### **NOTICE**

Specific driving instructions cannot be described in this instruction manual alone.

Always use the vehicle's mounted tool carrier incl. the attachment tool's instructional material for guidance on correct driving and use, in combination with the information given in this section.

The prescribed driving instructions with the attachment tool are based on the operator having understood both the operation and functions of the vehicle, the tool carrier and the attachment tool, as well as having carried out a complete implementation of all instructions in the section: [Preparing the machine for use](#) – page 48-52

All the functions of both the vehicle, the operation of the tool carrier, and the functions of the attachment tool should be understood with the operator, as it is a combination of these that determines the result of the e.g., fence and hedge cutting.

1. **Activate the tool carrier using its control panel and start the hydraulic supply so that the lift/arm system on the vehicle and tool carrier can move:**
- 

2. **Use the joystick and/or the functions of the control panel to control and position the Quadsaw to the position that is most appropriate for the work to be done. \***

**If a front loader is used together with a tool carrier and attachment tool, the working height can be advantageously adjusted via the front loader's lift system so that it is at a suitable height in relation to the terrain:**

---

3. **The working angle of the Quadsaw must be set to the best possible position using the tool carrier's controls. \***

**Adjust the Quadsaw so that it is at an angle of approximately 90° to the branches.**

**Always ensure that the blades run straight with the direction of travel/ cut vertically with the direction of travel to avoid warping of the saw blades during work.**

---

*\* Use the vehicle's and tool carrier's instruction material for correct setting and positioning.*

4. The direction of travel with attachment tools should take place forward and must follow the line of the "fence".

If a large branch comes directly against the branch guides, the cutting height is corrected so that it comes right on to the saw blade.

If small branches or other unwanted objects get between the saw blades and the body, the machine is stopped, and objects are removed/cleaned.

**⚠ DANGER**

If the saw blades are blocked: Stop the saw, stop the vehicle, remove the ignition key, apply the parking brake, and wear safety glasses and gloves before attempting to remove material/unwanted objects from the saw blades.

See section: [Start-up after unintended / accidental stoppage \(q\)](#) – page 62.

5. The forward speed when using the attachment tool must be max. 5-7 km/h (3-4 mph) but must always be adjusted so that the cutting result is optimal.

It is the individual attachment tool and the conditions under which work is done determine the speed at which it should be driven.

Table 34 – Driving instructions: LRS 2002 Quadsaw (2/2)

## 5.6.7 Start-up after unintended / accidental stoppage (q)

### NOTICE

In case of accidental stoppage of attachment tool and/or tool carrier, always follow the instructions given in the machines' instruction manuals.

See section: [Safety instructions for maintenance, adjustment, and inspection \(s\)](#) – page 15.

An unintended stoppage of operation can occur at any time. There can be various reasons, but often downtime can be avoided if the operator uses and maintains the machine correctly and avoids hitting:



- Bigger rocks
- Tree stumps
- Fence wire
- Manhole covers
- Litter
- Plastic and/or other packaging
- Bicycles/scrap

If the attachment tool hits any of the above objects, strong vibrations and/or increased noise will typically occur.

In the event of signs of strong vibration/noise in connection with the above, or in the event of e.g. leakage, lost and/or loose parts on the machine, the operator should do the following:

1. Stop the machinery immediately.
2. Tilt the attachment tool around and lower to a low height so that the machine's elements can be inspected.
3. **Pull the handbrake, switch off the vehicle, take out the key and make sure that the machinery has come to a complete stop!**
4. Attachment tools and tool carriers are inspected and checked:
  - If foreign bodies are found, these are released manually. (Fence wire, plastic etc.)
  - Check machine parts for cracks, breaks, missing parts, or any other damage.
  - Do not continue driving until all damage has been repaired.

Follow the recommendations below for starting the machinery after a shutdown:

- Follow the recommendations below for starting up after a shutdown:
- Restart the attachment tool slowly. (See the instruction manual for the tool carrier + section in this instruction manual: [Start of attachment tool](#) – page 55.
- Pay particular attention that both the attachment tool and the tool carrier work according to all guidelines stated in their instruction manuals.





## 6) Inspection and maintenance (e, r)

---

To ensure a long working life of the machine, good and careful inspection and maintenance is required.

Remember that the machine is designed to withstand the harshest conditions, and that with a little care and attention it will be able to give you many years of trouble-free operation.

To avoid problems and ensure that the warranty covers, always use original [GreenTec spare parts](#) and make sure that the machine is not used for anything other than described in this user manual.



The owner or operator must ensure that the machine is only used, maintained, inspected, and repaired by persons who are familiar with the procedures associated with it and are instructed in the associated dangers.

If doubts arise in connection with some of the procedures mentioned, contact an authorized specialist workshop or importer/retailer (See: [www.greentec.eu](http://www.greentec.eu))

Repair work that is not described in the user manual may only be carried out by authorized specialist workshops.

### IGNORING ONE OR MORE OF THE SAFETY INSTRUCTIONS MAY MEAN:

#### **⚠ DANGER**

**Great danger to people due to mechanical and chemical influences!**

#### **⚠ WARNING**

Danger to the environment due to leakage of hydraulic oil! Damage and defects to the attachment tool, Multi Carrier or the towing vehicle!

#### **NOTICE**

The warranty on the machine is void if one or more of the safety instructions are disregarded.

GreenTec is not liable for compensation claims for damages caused by incorrect use of the machine and incorrect connection or connected equipment, or by incorrect maintenance of the machine!

## 6.1) Instructions for safe maintenance and adjustment (s)

To avoid accidents during maintenance and adjustment, the following points must always be observed:

### **⚠ DANGER**

**All work on the machine must only be done when the machine is stopped, the vehicle is switched off, the handbrake is applied, and the key is removed from the ignition lock on the vehicle!**

**During maintenance work on lifted attachment tool, securing with suitable support elements must be carried out!**

**Only use suitable tools and use the prescribed personal protective equipment prescribed in this user manual!**

**Great care should be taken when working with the machines, as there is a danger of fingers and hands being trapped by e.g. drive belts, pulleys, blade blades, rotors, guards etc.!**

### **⚠ WARNING**

Immediately after finishing maintenance work, all safety and protective devices etc. mounted and activated again! During maintenance, you can often come into contact with hydraulic oil, gearbox oil and grease. Always avoid skin contact, inhalation, etc.!

Always use the correct protective equipment and use the safety data sheets for these!

ALWAYS dispose of oil and grease in a regulatory and environmentally sound manner!

### 6.1.1) Properly move your GreenTec machine

GreenTec recommends moving machines and attachment tools around on their supplied support devices/stands, or transport pallets (EU standard) if support devices are not available.

If machines are to be moved, always use a forklift or pallet lifter. Always check the weight of your GreenTec machine under the machine specifications.

Materials and components used in connection with moving the machine must be approved for *more than the stated weight of the machine*.

### **⚠ DANGER**

**There is a risk of crushing as the machine can turn/overturn during transport.**

**There must not be people on both sides of the machine during lifting, or in the area where the machine can tilt.**

**Never try to lift or move the Multi Carrier with the attachment tool attached! Attachment tools and Multi Carriers are moved separately from time to time as long as they are not mounted on a vehicle!**

## 6.2) Daily and routine inspections (e)

### ⚠ CAUTION

Before starting up a new machine, a daily inspection is carried out before starting up, and again already after **3-5 operating hours**. After this, a daily inspection after using the machine is sufficient, combined with a six-monthly inspection of the machine! (**Every 6 months**)

At the beginning of the machine's service life, extra attention should be paid to the tightening of bolts, shielding and any belt tension on attachment tools.

### NOTICE

Always remember to check the entire machinery, both vehicle, tool carrier and the attachment tool used. It is important that the operator knows the machines and carries out the daily and routine inspections necessary for the vehicle, the tool carrier and the attachment tools used.

For correct inspection and maintenance, the instruction manuals for the respective machines must be used at all times. (Vehicle, tool carrier and attachment tool) Always be safe in the daily routines and inspection of machines!

**Daily inspection is always carried out after the first 3-5 operating hours. All points MUST be reviewed! Thereafter, a daily inspection is carried out each time the machine is used:**

DAILY INSPECTION OF THE MACHINE:	
1. General overall impression of the machine:	Possible damage and/or errors must be corrected immediately.
2. Intact guards/shielding, incl. rubber flaps on attachment tools + belt housing:	All forms of guards/shielding must be intact.
3. Cracks in the frame's sides, corners and around the mounting points:	Also look for dents and/or bent parts.
4. Loose parts or missing bolts:	Retighten all bolts! (See section: <a href="#">Tightening of bolts</a> – page 67)
5. If belt-drive on attachment tools and equipment:	Check belt tension and tighten the belts, if necessary, on the equipment. (See section: <a href="#">Checking and adjusting the belt tension</a> - page 71-74)
6. Inspect the hydraulic system for leaks:	Check all hydraulic hoses incl. fittings + motor, flow divider etc. (See section: <a href="#">Tightening of hydraulic hoses- and fittings</a> – page 68)
7. Check hydraulic hoses and hose protection for correct guidance:	Check for wear marks and/or displaced hose protection. (See section: <a href="#">Hydraulic hoses</a> – page 69)
8. Lubrication of the entire machine:	If any, best done after finished work, as the components on the machine are hot here and possible water/moisture is thereby pressed out of e.g. bearings, bushings etc. (See section: <a href="#">Lubrication of the machine</a> – page 77)

Table 35 – Checklist for daily inspections: Before and after commissioning

Semi-annual inspection is always carried out after every 6 months. All points MUST be reviewed!

Thereafter, a daily inspection is carried out each time the machine is used:

SEMI-ANNUAL INSPECTION OF THE MACHINE:	
<b>1. General review of machinery:</b>	Do a careful daily inspection. Cleaning and maintenance/lubrication so that general maintenance is minimized. (See <a href="#">Table 35</a> – page 65)
<b>2. Clean the entire machine of loose branches and dirt:</b>	Wash and then lubricate the machine with anti-corrosion oil/grease where this is relevant. Especially on worn areas/parts of the machine! (See section: <a href="#">Cleaning the machine</a> – page 76)
<b>3. Carefully check the condition of all hydraulic hoses:</b>	Be aware that hoses do not rub against edges, flanges, bolts and the like. Hose protections are correctly fitted so that the hoses are always protected as best as possible. (See section: <a href="#">Hydraulic hoses</a> – page 69)
<b>4. Examine all bearings, and possibly shafts, rivets and bushings on the machine:</b>	See section: <a href="#">Bearings, shafts, rivets, and bushings</a> – page 70)
<b>5. Store the machine well protected and dry:</b>	Protect especially the hydraulic couplings on the attachment tool and tool carrier, and possibly bearings on work equipment against continuous rain, moisture, and temperature fluctuations. (See section: <a href="#">Storage of the machine</a> – page 78)

Table 36 – Checklist for semi-annual inspection: preventive maintenance

## 6.3) Tightening of bolts and hydraulic connections

### 6.3.1) Tightening of bolts

All bolts and nuts on the machine are provided with quality class marking. Ordinary machine steel bolts have quality class 8.8: bolts marked with 8.8, and nuts marked with 8.

Hardened steel bolts may be marked 10.9 or 12.9: bolts marked 10.9 or 12.9, and nuts marked 10 or 12.

Individual bolts and nuts have no markings: these are always ordinary steel bolts and/or nuts in quality class 8.8 / 8.

Below are the nominal tightening torques for steel bolts/set screws (ISO 4014/ISO 4017 standard), within the



Bolts / steel set screws

TIGHTENING OF BOLTS:			Regular steel bolts/set screws (Strength class 8.8) *	Hardened steel bolts/set screws (Strength class 10.9) *	Hardened steel bolts/set screws (Strength class 12.9) *
mm	mm	mm			
<b>M6</b>	1,00	10	9,8 Nm (7.23 lbf·ft)	14,0 Nm (10.33 lbf·ft)	17,0 Nm (12.54 lbf·ft)
<b>M8</b>	1,25	13	24,0 Nm (17.70 lbf·ft)	33,0 Nm (24.34 lbf·ft)	40,0 Nm (29.50 lbf·ft)
<b>M10</b>	1,50	16	47,0 Nm (34.67 lbf·ft)	65,0 Nm (47.94 lbf·ft)	79,0 Nm (58.27 lbf·ft)
<b>M12</b>	1,75	18	81,0 Nm (59.74 lbf·ft)	114,0 Nm (84.08 lbf·ft)	136,0 Nm (100.30 lbf·ft)
<b>M14</b>	2,00	21	128,0 Nm (94.40 lbf·ft)	181,0 Nm (133.50 lbf·ft)	217,0 Nm (160.05 lbf·ft)
<b>M16</b>	2,00	24	197,0 Nm (145.30 lbf·ft)	277,0 Nm (204.30 lbf·ft)	333,0 Nm (245.60 lbf·ft)
<b>M18</b>	2,50	27	275,0 Nm (202.83 lbf·ft)	386,0 Nm (284.70 lbf·ft)	463,0 Nm (341.50 lbf·ft)
<b>M20</b>	2,50	30	385,0 Nm (283.96 lbf·ft)	541,0 Nm (399.00 lbf·ft)	649,0 Nm (478.70 lbf·ft)
<b>M22</b>	2,50	34	518,0 Nm (382.06 lbf·ft)	728,0 Nm (536.90 lbf·ft)	874,0 Nm (644.60 lbf·ft)
<b>M24</b>	3,00	36	635,0 Nm (468.35 lbf·ft)	935,0 Nm (689.60 lbf·ft)	1120,0 Nm (826.00 lbf·ft)

\* Indicative values: Bolts and steel set screws (± 5%)

Table 37 – Tightening torques for bolts

### 6.3.2) Tightening of hydraulic hoses- and fittings

The hydraulic hoses and fittings used are all produced with metric threads.

Hydraulic connections are available in 2 series:

- Light-series (L): Used on hydraulic connections where the pressure does not exceed 250 bar.
- Heavy-series (S): Used on hydraulic connections where the pressure exceeds 250 bar, and up to 320 bar.

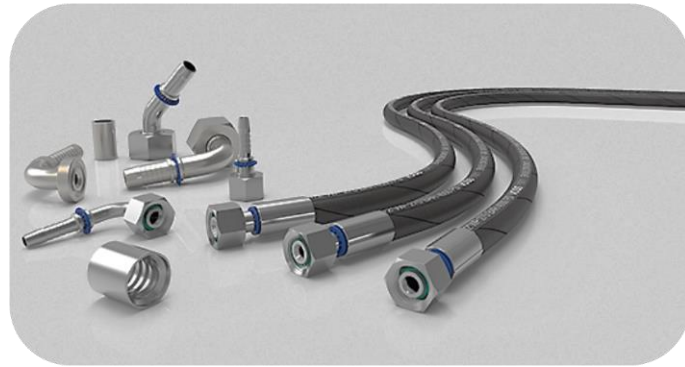

Hydraulic hoses and fittings

#### TENSIONING OF HYDRAULIC HOSES AND FITTINGS:

Size:	Series:	Tightening torque (Nm): *
<b>M12</b>	L 6	20,0 Nm (14.75 lbf·ft)
<b>M14</b>	L 8	30,0 Nm (22.13 lbf·ft)
<b>M16</b>	L 10	40,0 Nm (29.50 lbf·ft)
<b>M18</b>	L 12	50,0 Nm (36.88 lbf·ft)
<b>M22</b>	L 15	70,0 Nm (51.63 lbf·ft)
<b>M26</b>	L 18	90,0 Nm (66.38 lbf·ft)
<b>M30</b>	L 22	120,0 Nm (88.50 lbf·ft)
<b>M36</b>	L 28	160,0 Nm (118.00 lbf·ft)
<b>M14</b>	S 6	25,0 Nm (18.44 lbf·ft)
<b>M16</b>	S 8	40,0 Nm (29.50 lbf·ft)
<b>M18</b>	S 10	50,0 Nm (36.88 lbf·ft)
<b>M20</b>	S 12	60,0 Nm (44.25 lbf·ft)
<b>M24</b>	S 16	85,0 Nm (62.69 lbf·ft)
<b>M30</b>	S 20	140,0 Nm (103.26 lbf·ft)
<b>M36</b>	S 25	190,0 Nm (140.14 lbf·ft)

\* Indicative values: Hydraulic connections ( $\pm 5\%$ )

Table 38 – Tightening torques for hydraulic hoses and fittings

## 6.4) Hydraulic hoses

### ⚠ WARNING

When inspecting hydraulic hoses, any damage/defect must be rectified immediately. When searching for leaks, due to the danger, suitable aids must be used: protective glasses, work gloves + a piece of cardboard that quickly reveals a leak!

Thin jets of hydraulic oil under high pressure can penetrate the skin and cause serious injuries! In the event of injuries of this nature, seek immediate medical attention: **DANGER OF INFECTION!**

Check the condition of all hoses at regular inspections. Pay particular attention that they do not rub against edges, flanges, bolts etc., and that the stocking is correctly fitted, so that the hoses are always protected as best as possible.

Check all hydraulic hoses and fittings daily. Any damage or leakage must be repaired immediately. Hoses with damage/defects must be replaced.

GreenTec's hydraulic systems work at a very high pressure: from approx. 200 bar up to 320 bar (2900 – 4621 psi) Use only original hoses. A burst hose can be very dangerous!

When replacing hydraulic hoses, avoid twisting hoses and fittings.

- Use 2 spanners to loosen and tighten the hoses!
- Avoid over-tightening! (Correct tightening torques are given in the [Table 38](#) – page 68)
- If fittings or screw connections continue to leak, these must be replaced!

### ⚠ WARNING

A flexible hose must not be twisted during installation, as this will significantly reduce the life of the hose and may cause the connections to loosen.

To determine if a hose is twisted or not, the specification line running the length of the hose must be straight. **If the specification line spirals around the hose, the hose is twisted:**



### ⚠ WARNING

A flexible hose must never be stretched tightly between two fittings.

Approx. 5 to 8 percent of the total length should be allowed as slack to allow free movement under pressure. Under pressure, a flexible hose is compressed in length and expands in diameter.

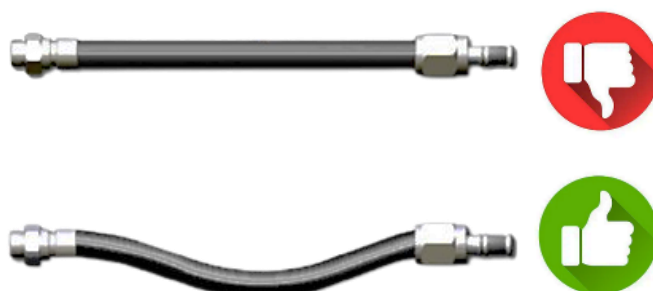

## NOTICE

The warranty of the hydraulic hoses is limited to the replacement of hoses due to defective material or manufacturing. The warranty for hydraulic hoses is void if:

- Hoses are damaged due to wear and tear.
- If the hoses have been cut or pinched during work.
- If threads etc. are damaged due to over-tightening.

## 6.5) Bearings, shafts, rivets, and bushings

### 6.5.1) Ball bearing w. rubber seals

It is always recommended to carry out a regular monitoring of the operating conditions of the bearings on the shafts of the saw blades.

Elements that should be checked from the bearings regularly during operation of the machine include **noise, vibration, temperature** and **lubrication**.

In general, if bearings are used under correct specified conditions, they will survive for the full manufacturer's estimated service life (hours).

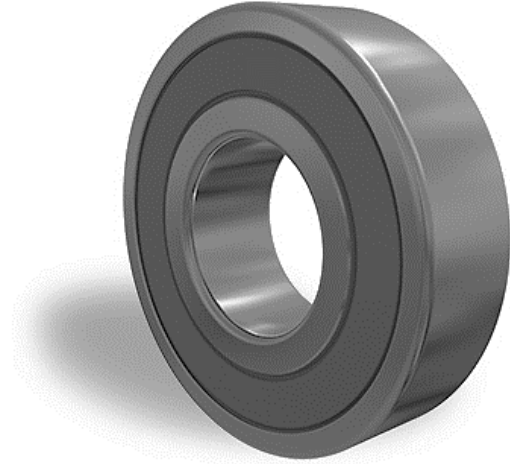

Single row ball bearing with rubber seals

## NOTICE

The bearings on the attachment tool are approved for more than twice the rotation speed of the knives/blades.

Bearings etc. most often fail as a result of errors that could have been avoided: incorrect assembly after replacement, handling or lubrication, ingress of foreign bodies or abnormal heat generation.

The bearings on the LRS 2002 Quadsaw have rubber seals and can therefore be considered "maintenance-free", as they are all sealed and do not require relubrication.

Rubber seals on both sides prevent loss of lubrication, and the bearings are pre-assembled from the factory with the correct amount of lubricant. Likewise, rubber seals prevent dirt, grime, and moisture from entering the bearings to avoid rust and ensure that the lubrication is not washed away.

## CAUTION

If sudden higher noise, vibration, or temperature level than normally perceived is experienced on the attachment tool, contact the dealer of the machine immediately!



## 6.6) Checking and adjusting belt tension

The belt tension on the machine is decisive for the overall function and performance of the attachment tool and must always be checked and approved before use.

**⚠ DANGER**

Great care must be taken when working with the machine's belt drive, as there is a risk of fingers and hands being pinched by the drive belt and pulleys!

### 6.6.1) Checking belt tension

For all machines with a belt drive, an [Optibelt OPTIKRIK](#) belt tension gauge is included, intended for easy and quick measurement of belt tension on the machine, both during maintenance of existing or when installing new belt(s).

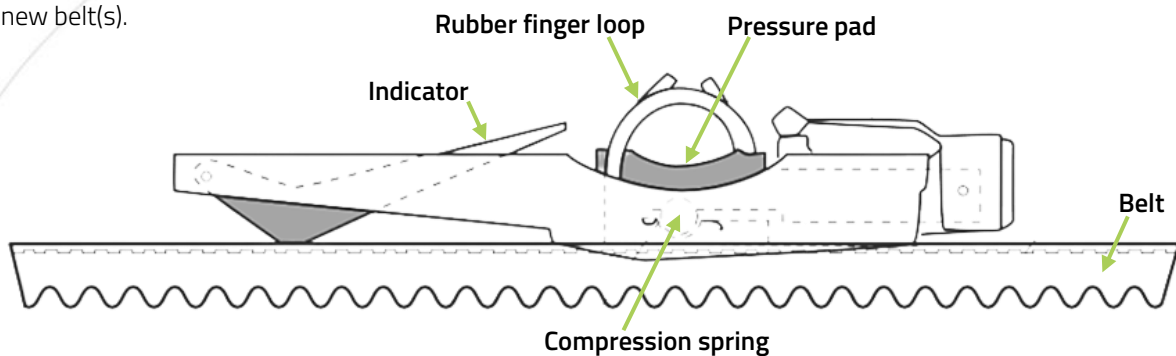

1. The belt tension gauge must be placed in the middle of the belt between two pulleys, with the indicator all the way down towards the back of the belt.

2. Place the belt tension gauge loosely on the center of the belt and slowly press down on the pressure surface using one finger.

- Avoid pressing the pressure pad with more than one finger. The illustration below (A, B and C) shows three ways to hold the meter so that pressure is only applied to the pressure pad itself:

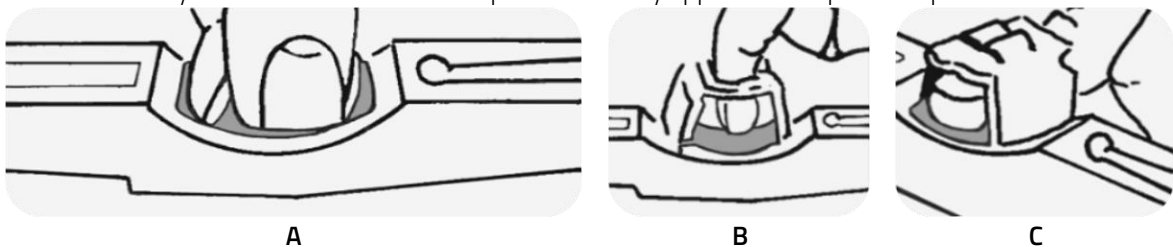

3. As soon as a distinct "click" is heard and/or felt, immediately release the pressure pad. The indicator arm remains in the measured position.

- Carefully lift the gauge from the belt without moving or affecting the indicator! Here, read the measurement at the exact point where the top surface of the indicator arm crosses the surface of the scale:

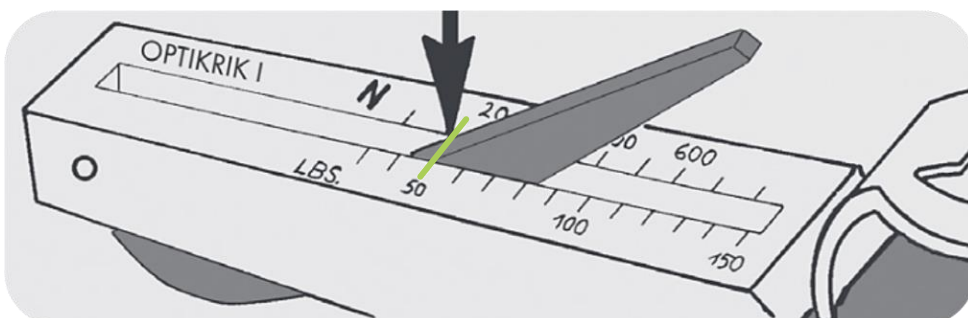

4. Based on the measurement result, the belt tension is increased or decreased so that the recommended tension matches the values indicated on the machine's belt tension diagram below.

See section: [Adjusting belt tension](#) – page 73-74.

**CAUTION**

After 3-5 operating hours with the machine, the belts have given way and must therefore be checked again!

**NOTICE**

Pay special attention to the fact that new belts on the machine must be tightened more than a corresponding existing belt. (+13-15%)

**BELT DIAGRAM: LRS 2002 QUADSAW**

R:

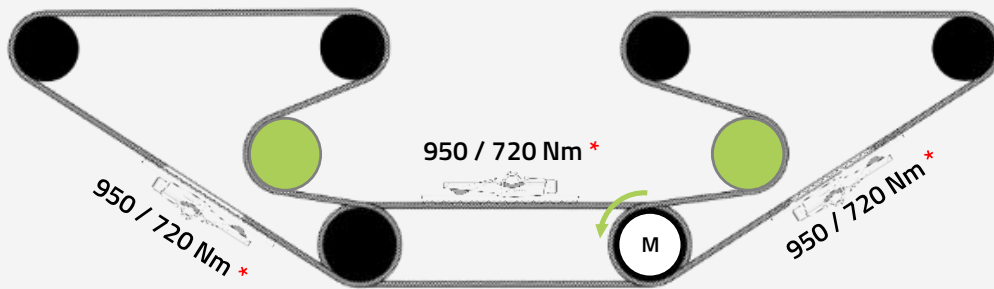

L:

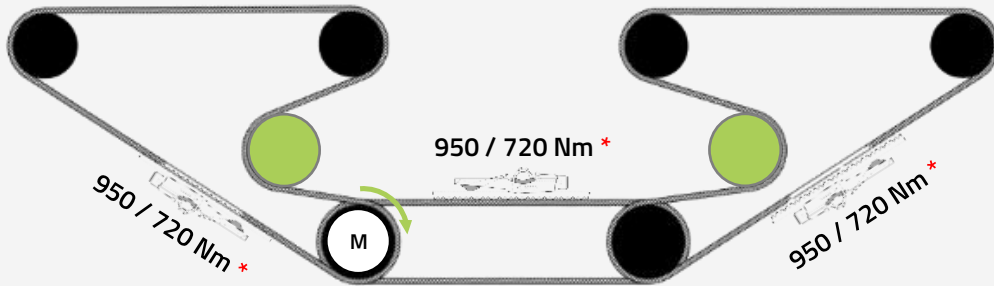

 = Belt tensioner wheel for tightening belts.

\* New belt: 950 Nm / Existing belt: 720 Nm (700.68 / 531.04 lbf·ft)

Table 39 – Belt diagram: LRS 2002 Quadsaw (right/left)

## 6.6.2) Adjusting belt tension

The belt tension on the LRS 2002 Quadsaw is adjusted by adjusting the belt tensioner wheels:

1. To gain access to belt tensioner wheels, remove the screens for the belt housing itself by removing 7x M10x20 bolts:

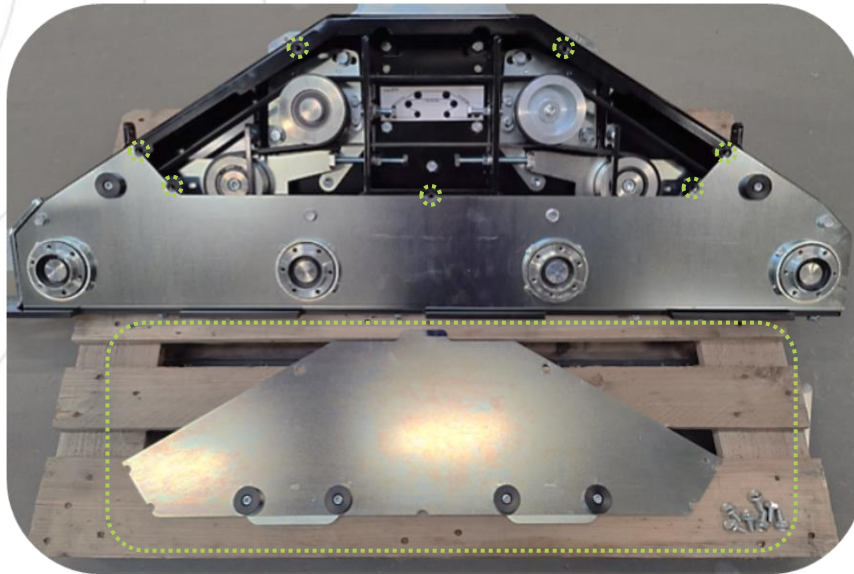

Removing screens for belt housing: LRS 2002 Quadsaw

2. Check/approve the belt tension for each of the 3 belts according to section on: [Checking belt tension](#) – page 71-72.

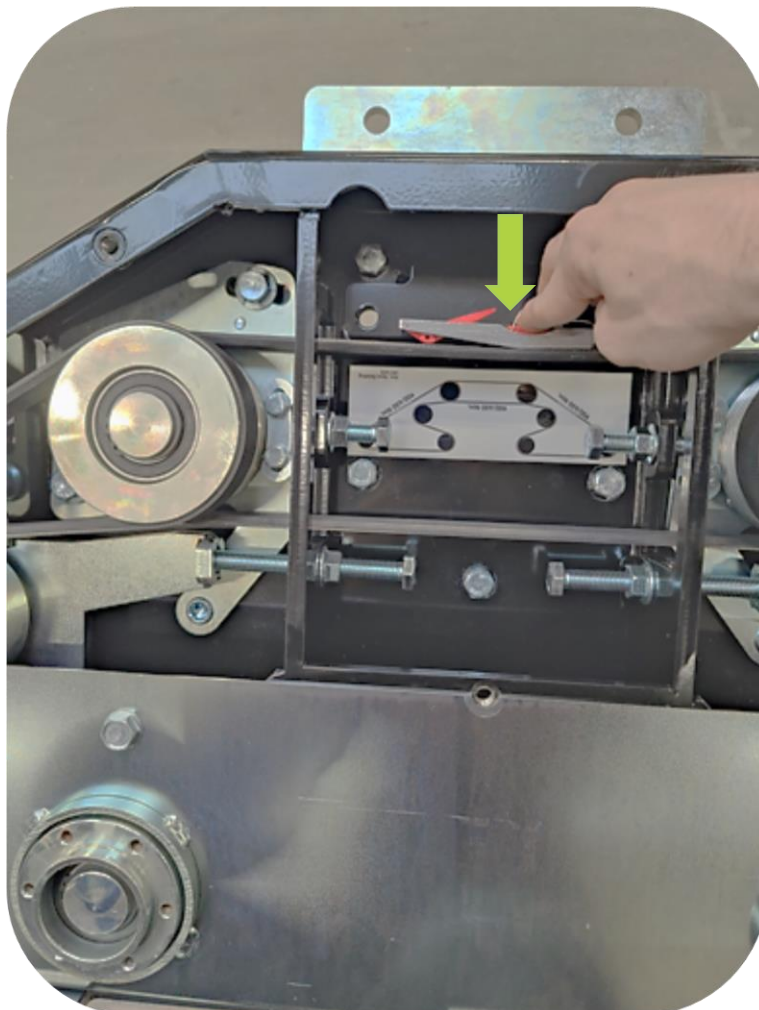

Reading belt tension using the belt tension gauge: LRS 2002 Quadsaw

3. Set/adjust the belts by first loosening the bolts (M12x25) for the belt tensioner pulleys. For this, there is a screw per belt tensioner wheel which is adjusted in/out to achieve the correct belt tension on the belts:

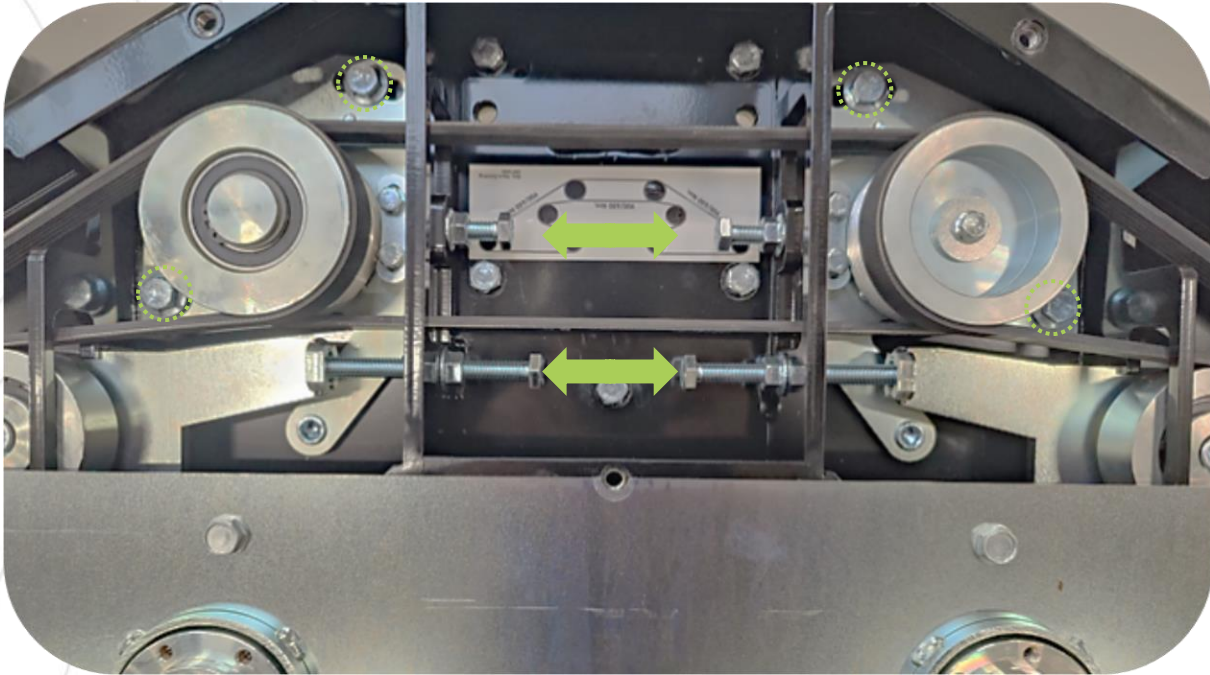

Setting/adjustment of belt tensioners: LRS 2002 Quadsaw

4. While setting/adjusting each belt tensioner wheel, check/read the belt tension over the entire belt, according to the section on: [Checking belt tension](#) – page 71-72.

## **NOTICE**

Always make sure to turn the pulleys/saw blades a little over repeatedly and read that there is the same tension over the entire length of the belt.

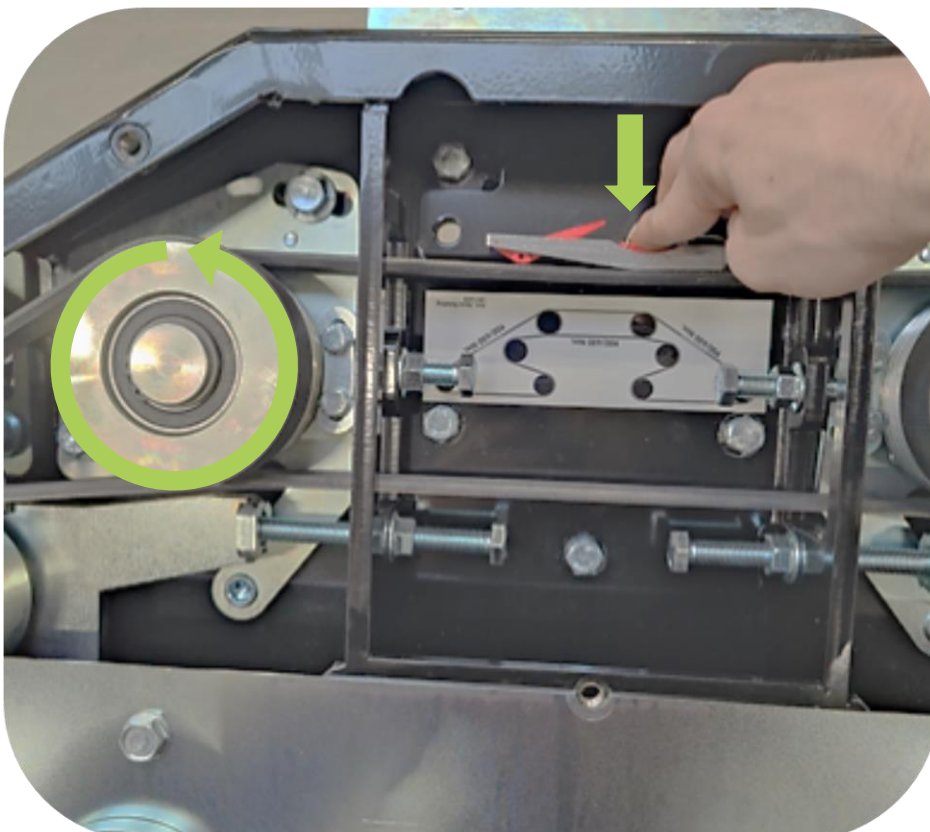

Checking the belt tension using the belt tension gauge: LRS 2002 Quadsaw

## 6.7) Checking pressure- and flow specifications

During service and maintenance of the machine, there may be a need to check, diagnose or verify the pressure and or flow specifications of the attachment tool. The total pressure of the machine is measured using manometers and/or flow meters. There is a large selection of pressure gauges, flow meters, test couplings and other digital equipment for measuring and testing hydraulic systems. When choosing the right equipment, it is important to have details in place about: connection, thread size, accuracy, and compatibility.

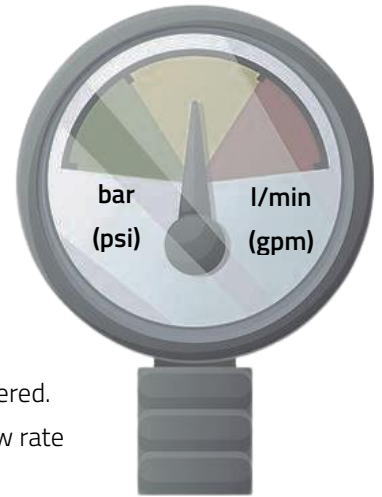

- **Manometer** – A manometer is a measuring instrument for measuring the physical pressure (bar/psi) with which the hydraulic oil in the system is delivered.
- **Flowmeter** – A flow meter is a measuring instrument for measuring the flow rate (l/min/gpm) with which the hydraulic oil is delivered.
- **Test coupling** – A test coupling/test nipple makes it easy and safe to connect analog or digital measuring instruments to the system to make pressure and flow measurements.

### 6.7.1) Correct measurement of pressure and flow

The table below shows which pressure and flow specifications the attachment tool must work with. See section: [Specifications](#) – page 34.

#### NOTICE

If there is a need to measure pressure and/or flow on the attachment tool, it is recommended to fit a test coupling for measurement. Measurement of pressure and flow should always be carried out at the flanges of the hydraulic motor, in order to achieve the most correct measurement.

#### CAUTION

To keep test couplings as clean as possible while they are not in use, it is recommended to use a rubber cap to put over the nipple so that dust/dirt does not enter the coupling when it is not connected to measurement and test equipment.

#### MEASUREMENT OF PRESSURE AND FLOW: LRS 2002 QUADSAW

<b>P-hose (Pressure): Size 3/8" (M14)</b>	50 l/min @ max. 190 bar (13.21 gpm @ 2756 psi) or 85 l/min @ min. 150 bar (22.45 gpm @ 2176 psi)
<b>T-hose (Tank/Return): Size 1/2" (M16)</b>	Min. 5 bar (72.52 psi) / Max. 15 bar (217.56 psi)
<b>D-hose (Drain): Size 1/4" (M12)</b>	Max. 0-2 bar (29 psi)

#### Placement of test coupling/test nipple:

When pressure and/or flow is measured on the attachment tool, it is measured just in front of the machine's hydraulic motor,

that is between connection of motor flanges and hydraulic hoses:

(This applies to all 3 hydraulic hoses: **Pressure**, **Return**, and **Drain**.)

Start-up tool carrier and attachment tool under normal operating conditions, and then operate the various functions of the machine.

Simultaneously read the manometer during use!



Table 40 – Measurement of pressure and flow: LRS 2002 Quadsaw

## 6.8) Cleaning the machine

### CAUTION

Be careful when using high-pressure cleaner close to the paint!

Steam cleaners are used with great care around the machine's labels/stickers!

Avoid harsh cleaning agents to avoid discoloration or damage to the paint!

It is important to store the machine covered so that it is protected from rain and sunlight. It must be placed on a flat surface or pallet!

Make sure that when storing the machine, there is no risk of it tipping over or falling down. Make sure for a suitable storage location or support of the machine!

Lubricate the machine with anti-corrosion oil afterwards, especially on the worn parts, also on the blades, rotors and internal shields of the attachment tool. This minimizes the formation of rust and prolongs the shelf life significantly!

See section: [Lubrication of the machine](#) – page 77.

## 6.9) Lubrication of the machine

There are no moving parts on the LRS 2002 Quadsaw that require lubrication. The bearings around the saw blade shafts are self-lubricating, with rubber seals, and thus maintenance-free.

See section: [Ball bearings w. rubber seals](#) – page 70.

It is an advantage after cleaning the machine to coat the saw blades with any brand of anti-corrosion oil, so that the metal is protected against rust build-up and the service life is extended.

Lubrication will also help the saw blades make a cleaner cut.

With each lubrication with anti-corrosion oil, this is polished into the surface with a paper towel or similar. Saw blades are coated in anti-corrosion oil



### **⚠ DANGER**

**Anti-corrosion oils are dangerous on the skin and by inhalation! Know and use all safety regulations when using the oil!**

### **NOTICE**

GreenTec ALWAYS recommends lubricating both the attachment tool and the tool carrier after the end of the work cycle, as the greasing points that have been most heavily loaded are still hot, and possibly dirt, acid, moisture, water, and grass are squeezed out immediately. Always refer to the instruction manual for used tool carriers!

### 6.9.1) Worn / shiny metal parts

It is an advantage after cleaning the machine to coat the blades/knives with any brand of anti-corrosion oil, so that the raw metal is protected against rust build-up and the service life is extended.

Lubricate the machine with anti-corrosion oil afterwards, especially on the worn and shiny parts, but also on the blades/knives, rotors and inner shields of the tool. This minimizes the formation of rust and significantly extends the service life!

Lubrication will also help the blades/knives to make a cleaner cut.

After each application of anti-corrosion oil, polish it into the surface with a paper towel or similar.

### **⚠ DANGER**

**Anti-corrosion oils are dangerous to the skin if inhaled! Know and use all safety regulations when using the oil!**

## 6.10) Storage of the machine

Always store the machine so that it is protected from moisture, wind, and weather. Before putting the machine away for storage, it must be washed and dried carefully. Also remove all traces of leaves / branches and dirt.

### **CAUTION**

GreenTec's machines **MUST** be stored dry, due to the risk of water in bearings, bushings and possibly electrical parts.

### **NOTICE**

Do not leave hydraulic hoses lying on the floor. They pose a tripping risk and there is a chance of contamination of hydraulic interconnections! Always lay all hoses over the machine/tool!

### **NOTICE**

Always store work tools in a cleaned and dried condition! Dirt attracts moisture and will thus result in increased rust formation. Damage to the paint must be repaired immediately!

## 6.11) Disposal of machine/machine parts

### **NOTICE**

To ensure the most environmentally sound disposal method, the machine/machine parts must be disassembled, and the disassembled parts sorted into the following categories below:

#### DISPOSAL OF MACHINE PARTS:

<b>Rubber and plastic parts</b>	Belts, rubber curtains, support wheels, plastic components, etc.
<b>Technical components</b>	Motors, valve blocks, hydraulic hoses, etc.
<b>Iron and Metal</b>	Plates, profile pipes, tubes, bearing housings, knives, blades, pulleys, etc.
<b>Chemistry</b>	Hydraulic oil, grease etc.

Table 41 – Overview of the disposal/scraping of machine parts



# 7) Troubleshooting the machine

## 7.1) Troubleshooting procedures

If the LRS 2002 Quadsaw does not work correctly, the source of the error must be located on the machine. Faulty conditions on the machinery can be isolated by examining the following:

### 1. Where on the machinery is there an error / faulty condition?

(Errors can occur on the **attachment tool**, on the **tool carrier** and/or on the **vehicle** used)

### NOTICE

When troubleshooting the tool carrier and/or vehicle, refer to the instruction materials for these.

### 2. What type of error /faulty condition?

- Is the error / failure **mechanical**? (Error on the mechanical parts)
- Is the error / failure **hydraulic**? (Error on the hydraulic parts)
- Is the error / failure **electrical**? (Error on the tool carrier and/or the vehicle's electrical system)

#### TROUBLESHOOTING INDEX: LRS 2002 QUADSAW

PROBLEM:	CAUSE:	SOLUTION:
<b>Lack of power/power transmission</b>	Insufficient oil pressure and/or flow to the attachment tool.	Examine and check the hydraulic supply from the vehicle/tool carrier to the attachment tool.
		Examine and verify the PTO revolutions from the vehicle.
<b>Oil motor leaking</b>	Too high drain pressure shoots the oil seal out of the engine: Max. 0-2 bar (Max. 0 – 29 psi)	Research and verify the machine's recommended pressure specifications. See section: <a href="#">Mounting and connection of the machine (i)</a> – page 42-47 + <a href="#">Checking pressure- and flow specifications</a> – page 75.
<b>Poor cutting quality</b>	Worn saw blades.	Replace or sharpen saw blades.
	Driving too fast.	Reduce forward speed: Max. 5 km/h. (3.10 mph)
	Revolutions on saw blades too low.	Check and adjust for correct oil flow: 40 l/min @ max. 190 bar (10.57 gpm @ max. 2756 psi)
	Thickness of material.	Max. branch thickness: < 12 cm (4.72")

(Continued) →

<b>Severe belt wear</b>	Incorrect belt tension.	Check and adjust belt tension. See section: <a href="#">Checking and adjusting belt tension</a> – page 71-74.
	Foreign bodies in wedge tracks.	Remove foreign objects.
	Overloading of attachment tool.	Reduce forward speed and/or oil supply.
<b>Abnormal vibration level</b>	High shock load.	Reduce forward speed: Max. 5 km/h (3.10 mph).  Reduce material thickness: Max. < 10 cm. (< 3.94")
	Defective bearings.	Replace bearings.
<b>Abnormal noise level</b>	Defective bearings.	Replace bearings.

Table 42 – Identifying error / faulty conditions

## 8) Appendix

---

### 8.1) Hydraulic diagrams

**NOTICE**

Contact GreenTec's Aftersales service department.

NOTES:

A series of horizontal dashed lines for writing notes, starting from the 'NOTES:' label and extending across the page.



A series of horizontal dashed lines spanning the width of the page, providing a template for handwriting practice. The lines are evenly spaced and extend across most of the page's width.



The original content of this user manual cannot be re-produced, distributed, transmitted, transcribed, or translated without the prior written permission from GreenTec.

Copyright © 2025 GreenTec A/S  
All rights reserved.

 **Made in Denmark**  
Designed and manufactured

